



PORSCHE

Aperçu des modèles Porsche Classic

Désignation des modèles	Année-modèle (AM)	Désignation des modèles	Année-modèle (AM)
356 Urmodell/356 A/356 B/356 C:		944:	
356 Coupé, tous dérivés	AM 1948 à 1965	944 Coupé, tous dérivés	AM 1982 à 1991
356 Cabriolet, Speedster American-Roadster, tous dérivés	AM 1948 à 1965	944 Cabriolet, tous dérivés	AM 1989 à 1991
356 Convertible-D (Hardtop)/ Hardtop-Cabriolet, tous dérivés	AM 1952 à 1965	959:	
550:		959 Coupé, tous dérivés	AM 1986 à 1988
550 Coupé, tous dérivés	AM 1952 à 1957	911 (964):	
550 Spyder, tous dérivés	AM 1953 à 1957	911 Coupé, tous dérivés	AM 1989 à 1994
911 Urmodell:		911 Targa, tous dérivés	AM 1990 à 1994
911 Coupé, tous dérivés	AM 1965 à 1973	911 Cabriolet, Speedster, tous dérivés	AM 1990 à 1994
911 Targa, tous dérivés	AM 1965 à 1973	911 Turbo, tous dérivés	AM 1990 à 1994
911 G-Model:		968:	
911 Coupé, tous dérivés	AM 1974 à 1989	968 Coupé, tous dérivés	AM 1991 à 1995
911 Targa, tous dérivés	AM 1974 à 1989	968 Cabriolet, tous dérivés	AM 1991 à 1995
911 Cabriolet, tous dérivés	AM 1983 à 1989	911 (993):	
911 G-Model Turbo (930):		911 Coupé, tous dérivés	AM 1994 à 1998
911 Coupé, tous dérivés	AM 1975 à 1989	911 Targa, tous dérivés	AM 1994 à 1998
911 Targa, tous dérivés	AM 1986 à 1989	911 Cabriolet, tous dérivés	AM 1994 à 1998
911 Cabriolet, tous dérivés	AM 1986 à 1989	Boxster (986):	
912:		Boxster Cabriolet, tous dérivés	AM 1997 à 2004
912 Coupé, tous dérivés	AM 1965 à 1969	911 (996):	
912 Coupé E, tous dérivés	AM 1976	911 Coupé, tous dérivés	AM 1998 à 2005
912 Targa, tous dérivés	AM 1965 à 1969	911 Targa, tous dérivés	AM 1998 à 2005
914:		911 Cabriolet, tous dérivés	AM 1998 à 2005
914 Targa, tous dérivés	AM 1970 à 1976	980:	
924:		Carrera GT, Cabriolet, tous dérivés	AM 2003 à 2006
924 Coupé, tous dérivés	AM 1976 à 1988		
928:			
928 Coupé, tous dérivés	AM 1977 à 1995		

Mentions légales :



PORSCHE

Mentions légales :

Les fiches de données des véhicules Porsche pour interventions de secours ont été rédigées à l'attention des équipes d'intervention ayant reçu une formation spécifique en matière de secours aux personnes se trouvant à bord d'un véhicule accidenté. Elles ne doivent être utilisées que dans cette seule optique.

Elles comportent notamment des informations sur la composition de la carrosserie, des systèmes de sécurité passive et des systèmes annexes de motorisation, en présentant le plus de variantes d'équipements possible.

La société Porsche n'est pas spécialisée dans l'organisation des secours en cas d'accident de la route. Avant toute intervention, les équipes d'intervention devront par conséquent évaluer ces informations et juger, sur la base de leurs connaissances techniques, des stratégies à adopter et des décisions à prendre. Nous recommandons à toutes les équipes d'intervention de pratiquer des exercices d'intervention sur des véhicules représentatifs de la marque Porsche afin de comprendre pleinement ces informations.

Cet ouvrage, en tout ou partie, est protégé par les droits d'auteur. Toute exploitation ou utilisation commerciale sans le consentement écrit préalable de la société Porsche AG est illicite. Cela vaut notamment pour la reproduction, la modification, l'adaptation, la traduction, la représentation sous forme de microfilm, ainsi que l'enregistrement et/ou la conversion sous forme électronique, y compris des bases de données et des services en ligne.

Porsche AG se réserve expressément le droit d'adapter ou de modifier à tout moment le contenu des fiches de données pour interventions de secours. Les informations étaient actuelles au moment de l'élaboration de ce CD. Porsche décline toute obligation d'actualisation, de modification ou de remplacement de ces informations.



Porsche AG, 356 Urmodell, 356 A, 356 B, 356 C

Coupé, tous dérivés

PORSCHE AM 1948 à AM 1965

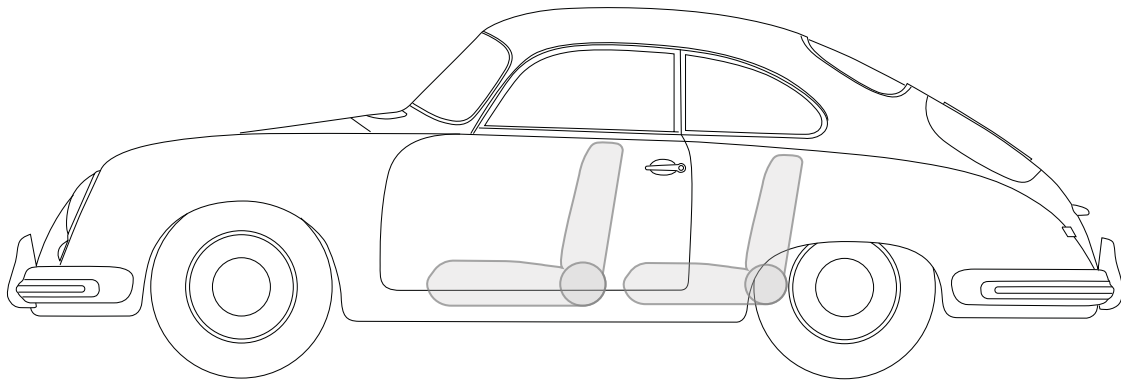
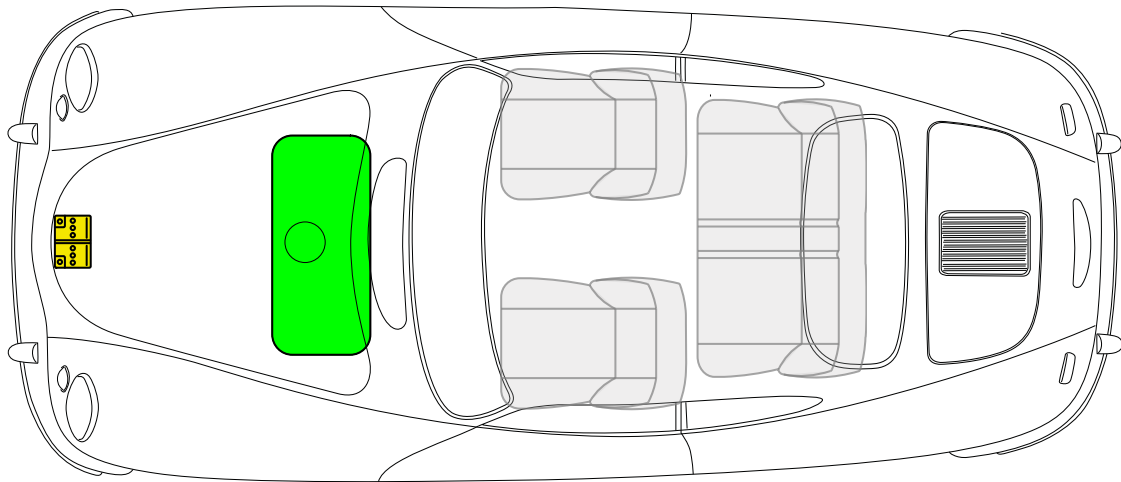

Réservoir de carburant

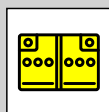

Batterie 12 volts



Porsche AG, 356 Urmodell, 356 A, 356 B, 356 C

Cabriolet, tous dérivés

PORSCHE AM 1948 à AM 1965

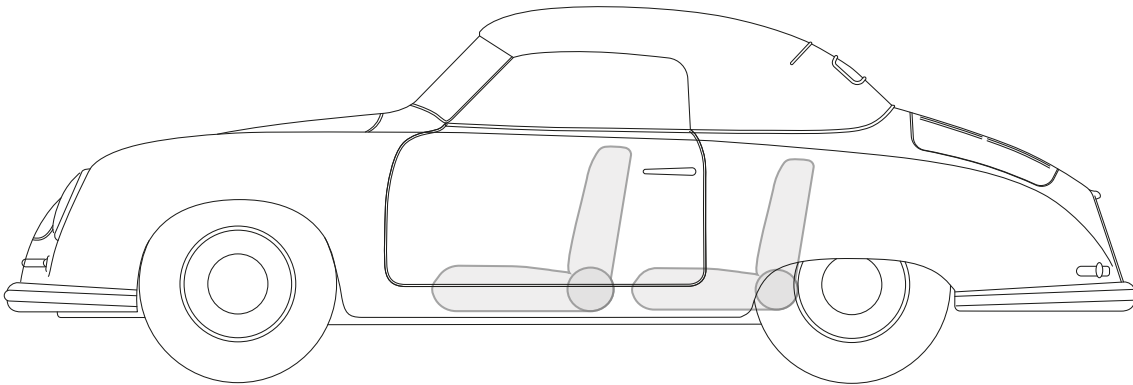
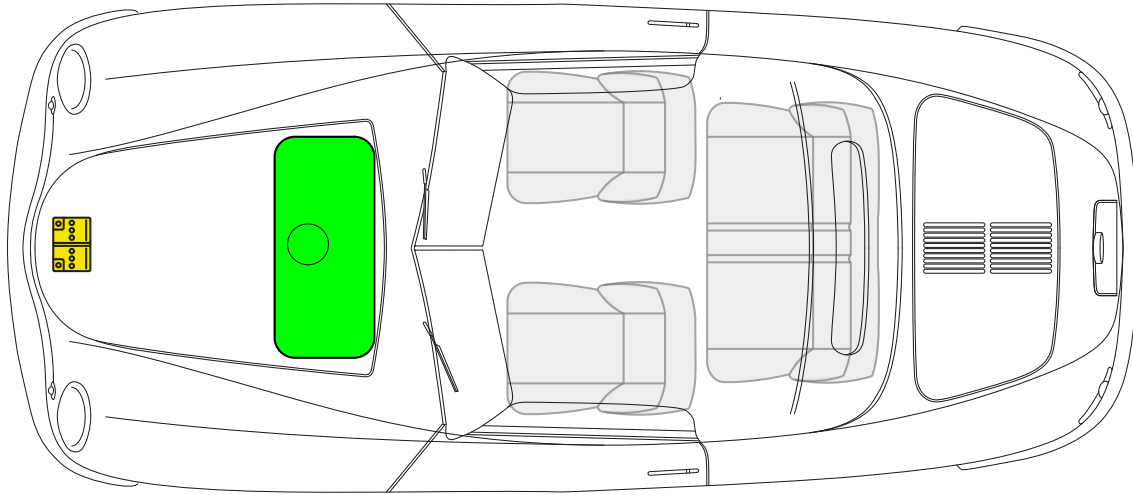

Réservoir de carburant

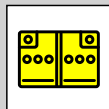

Batterie 12 volts



Porsche AG, 356 Urmodell, 356 A, 356 B, 356 C
Convertible-D (Hardtop), Hardtop-Cabriolet, tous dérivés
AM 1952 à AM 1965

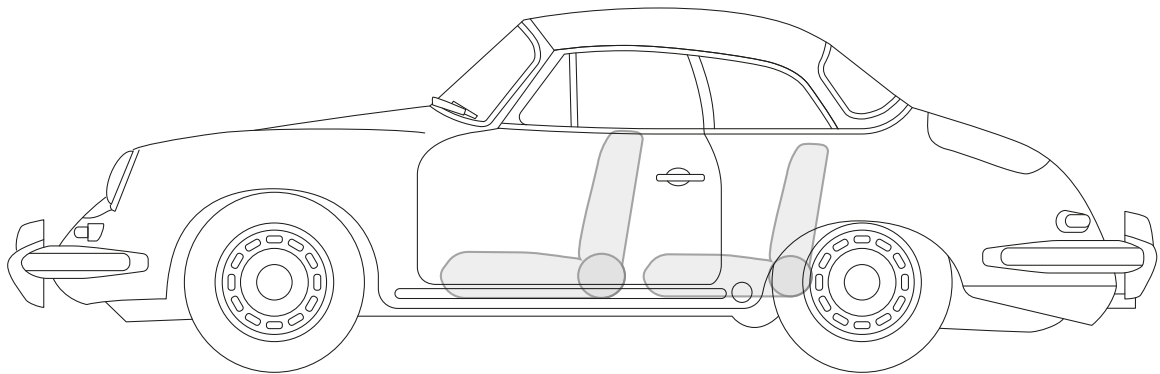
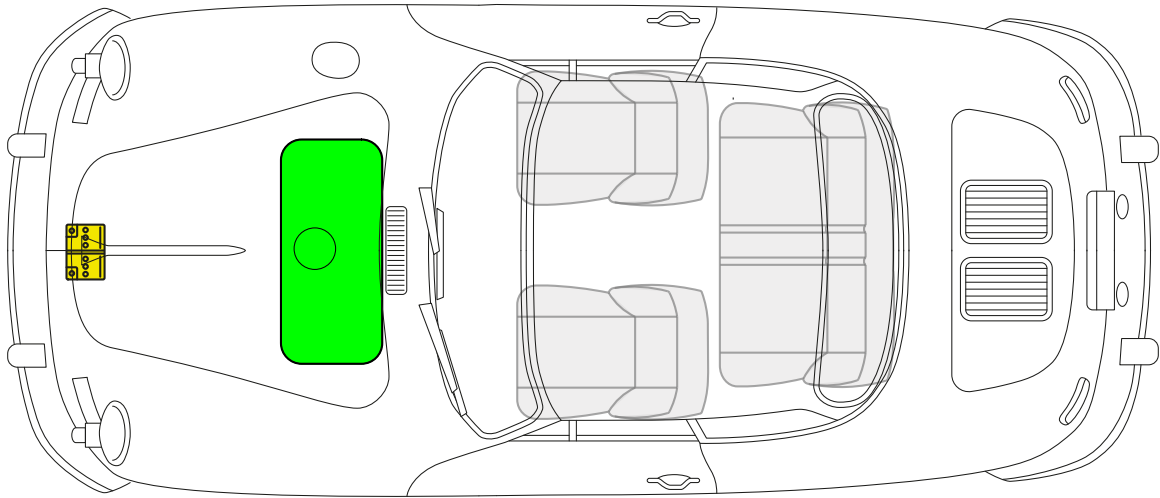

Réservoir de carburant

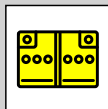

Batterie 12 volts



Porsche AG, 550, Coupé, tous dérivés

PORSCHE AM 1952 à AM 1957

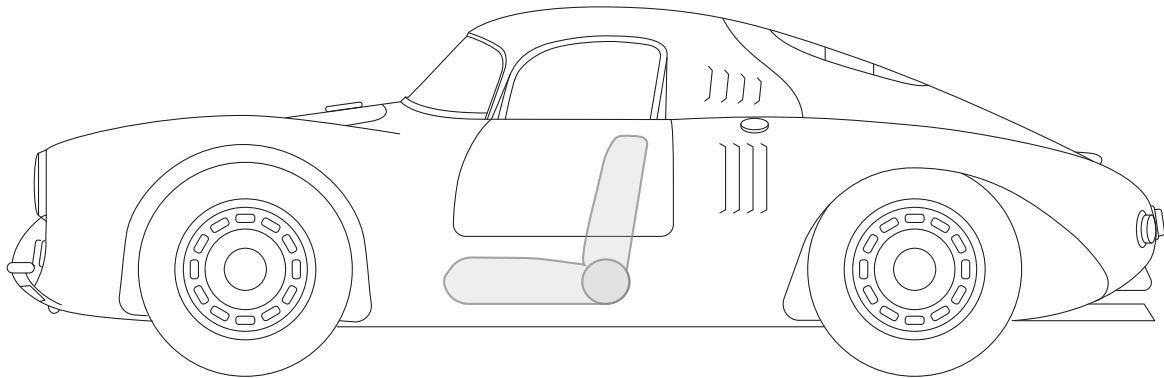
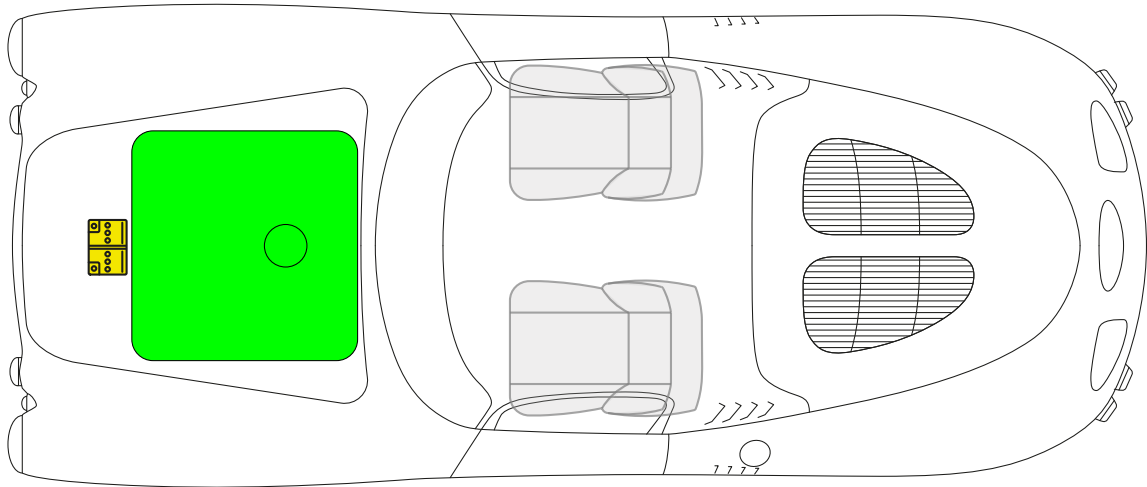

Réservoir de
carburant

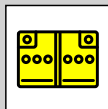

Batterie
12 volts



**Porsche AG, 550, Spyder,
tous dérivés**

PORSCHE AM 1953 à AM 1957

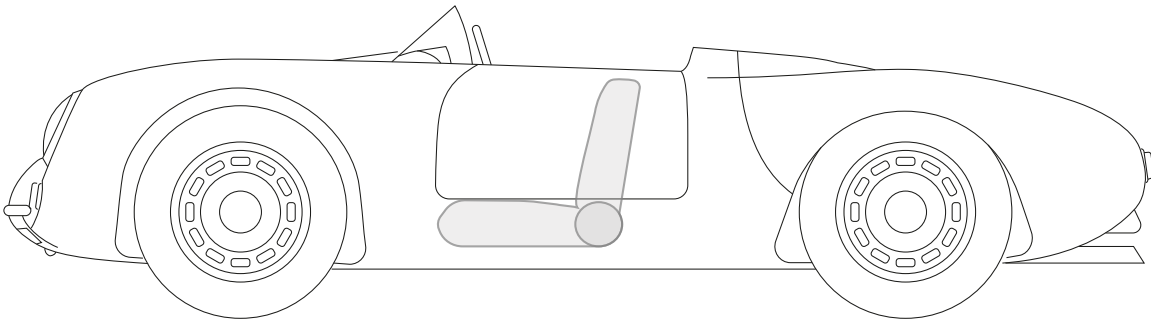
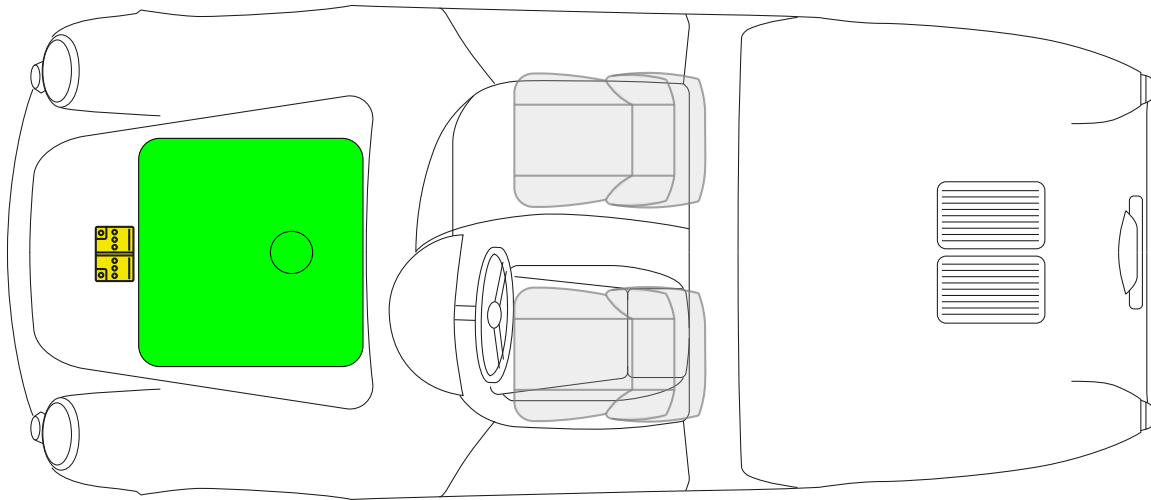

Réservoir de
carburant

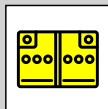

Batterie
12 volts



Porsche AG, 911 Urmodell, Coupé, tous dérivés

PORSCHE AM 1953 à AM 1957

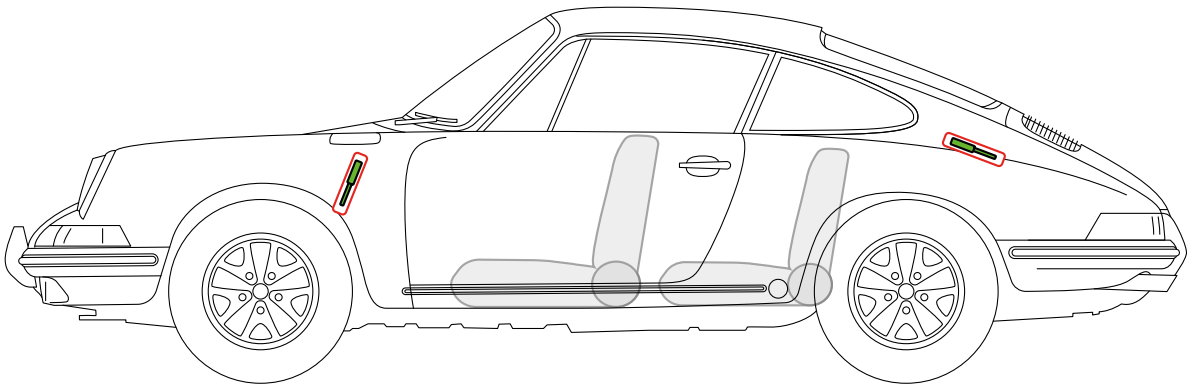
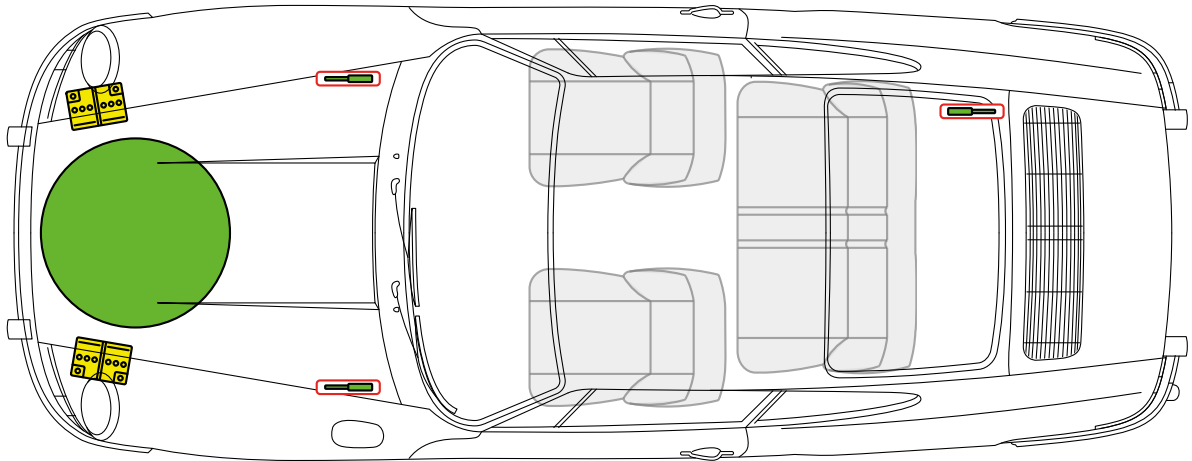
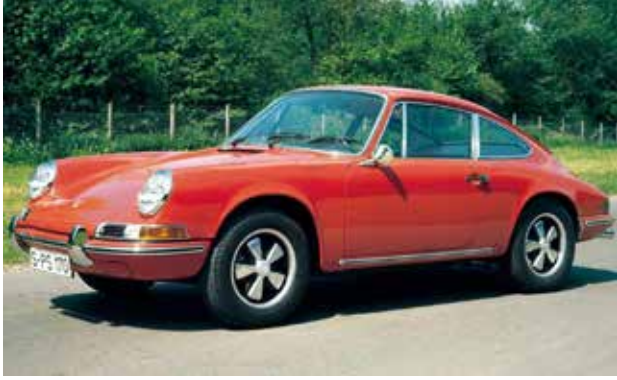

Réservoir de
carburant

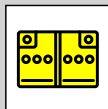

Batterie
12 volts

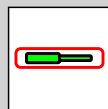

Amortisseur à
gaz



Porsche AG, 911 Urmodell, Targa, tous dérivés

PORSCHE AM 1965 à AM 1973

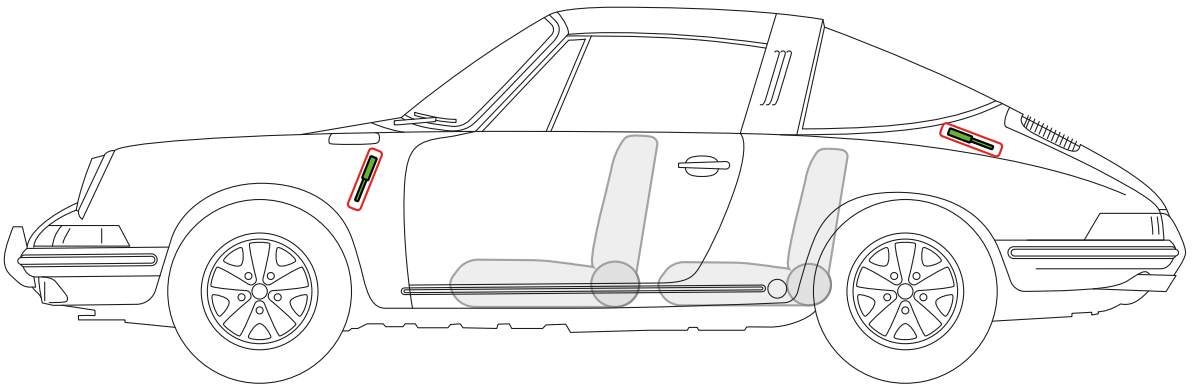
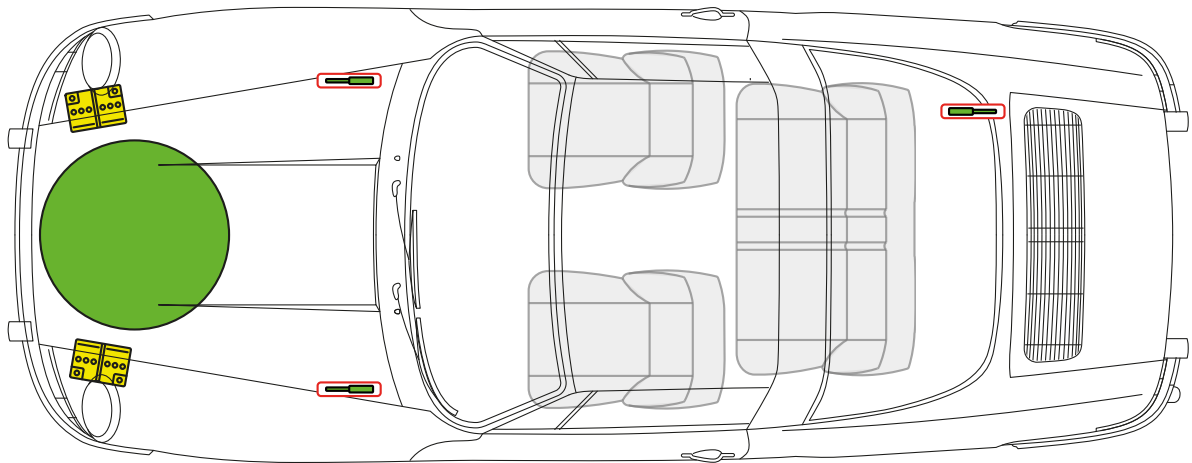

Réservoir de carburant

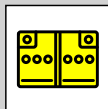

Batterie 12 volts

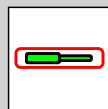

Amortisseur à gaz



**Porsche AG, 911 G-Model, Coupé,
tous dérivés**

PORSCHE AM 1974 à AM 1989

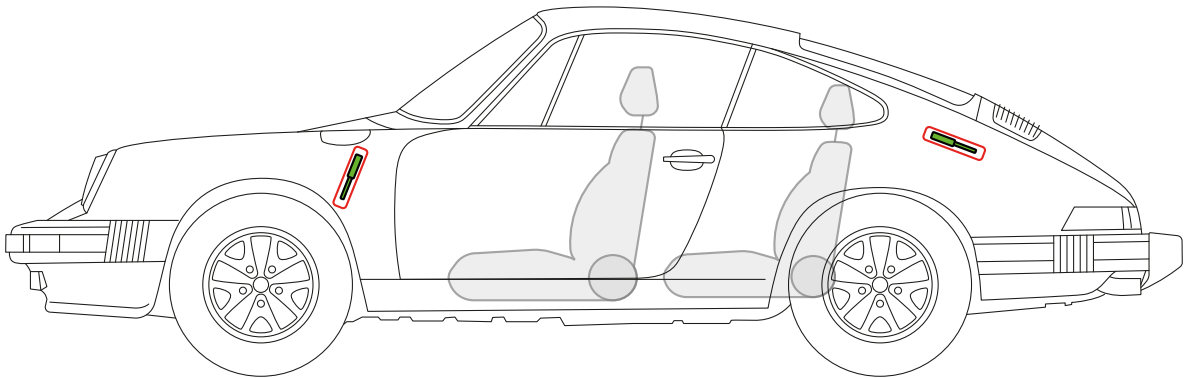
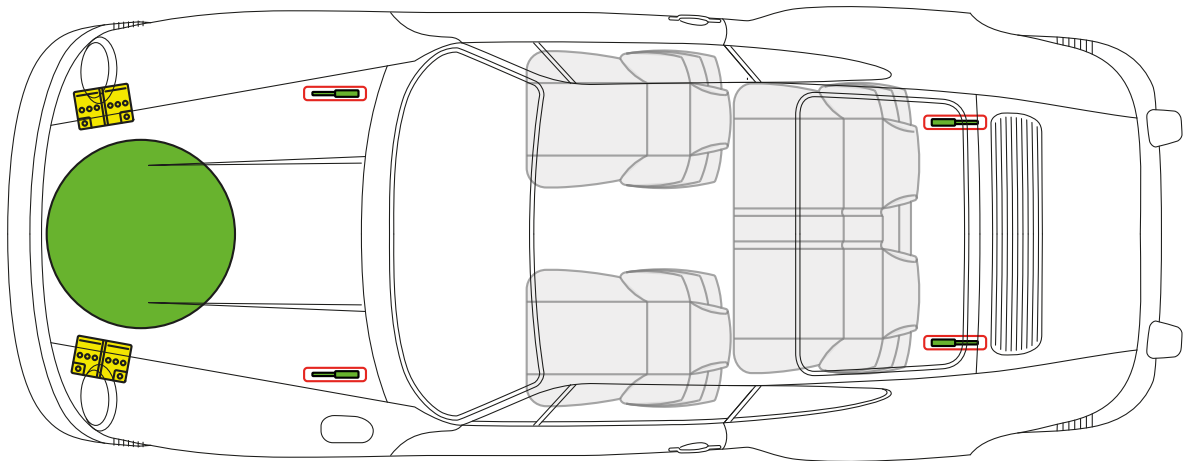
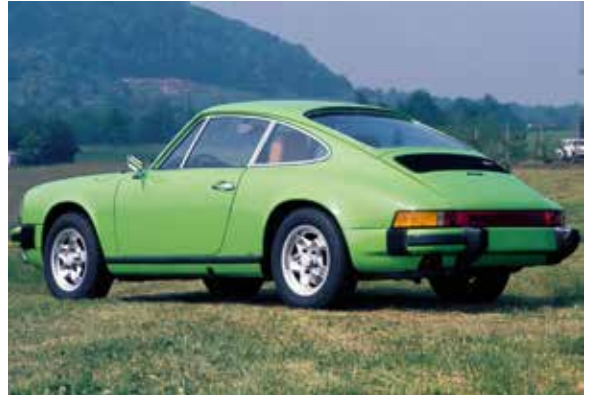

Réservoir de
carburant

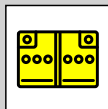

Batterie
12 volts

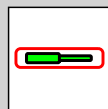

Amortisseur à
gaz



**Porsche AG, 911 G-Model, Targa,
tous dérivés**

PORSCHE AM 1974 à AM 1989

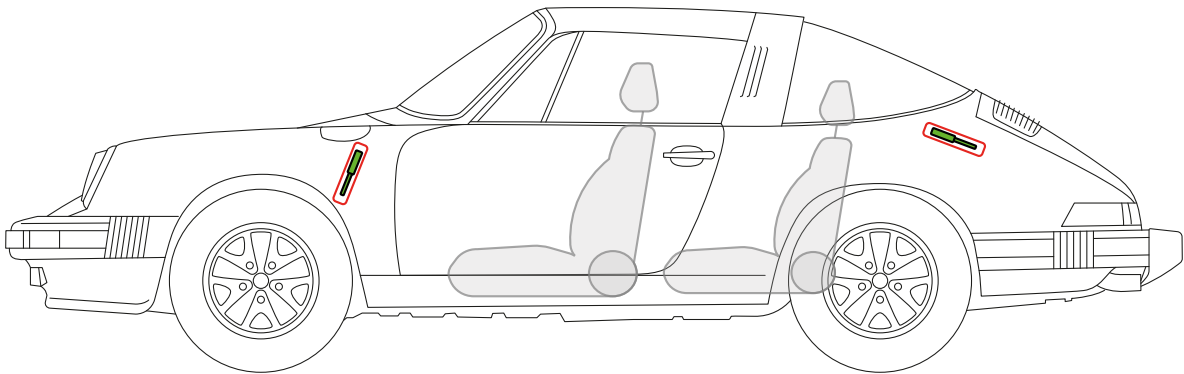
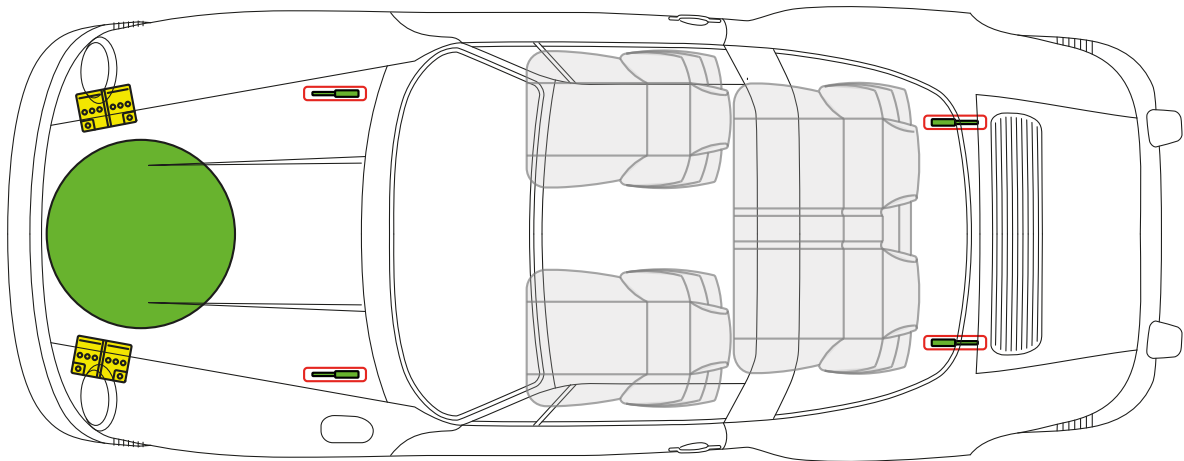

Réservoir de carburant

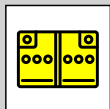

Batterie 12 volts

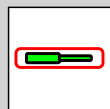

Amortisseur à gaz



Porsche AG, 911 G-Model, Cabriolet, tous dérivés

PORSCHE AM 1983 à AM 1989

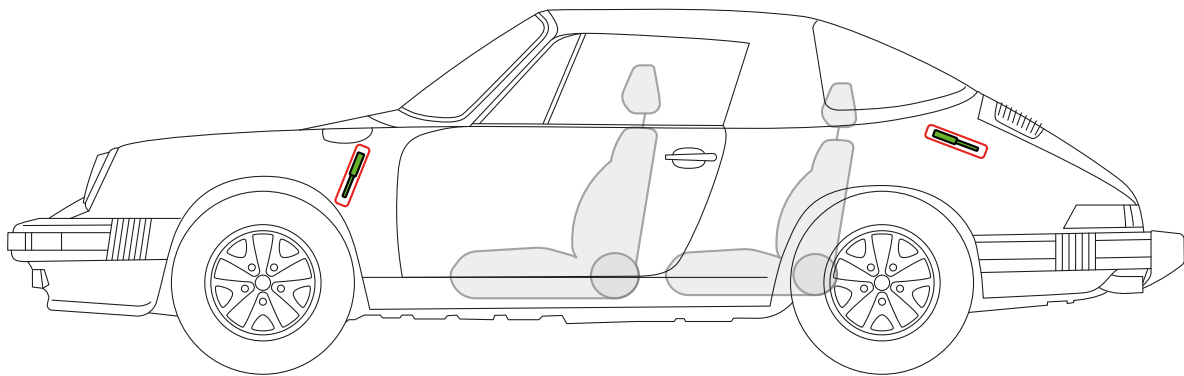
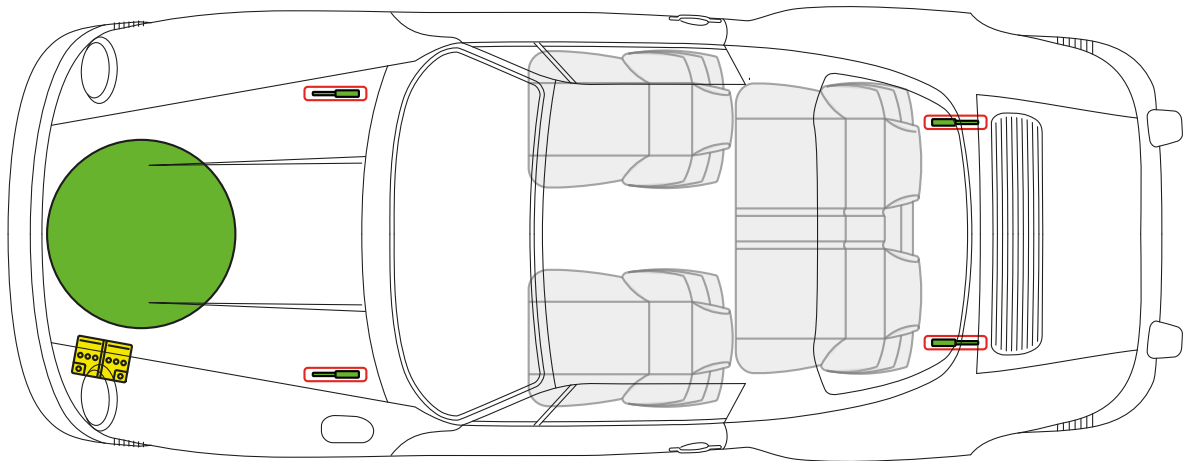

Réservoir de carburant

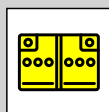

Batterie 12 volts

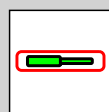

Amortisseur à gaz



Porsche AG, 911 G-Model Turbo (930), Coupé, tous dérivés

PORSCHE AM 1974 à AM 1989

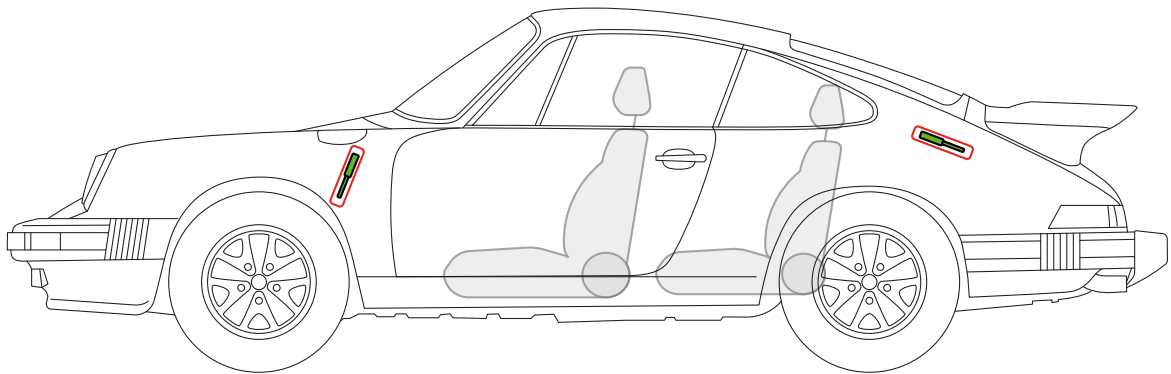
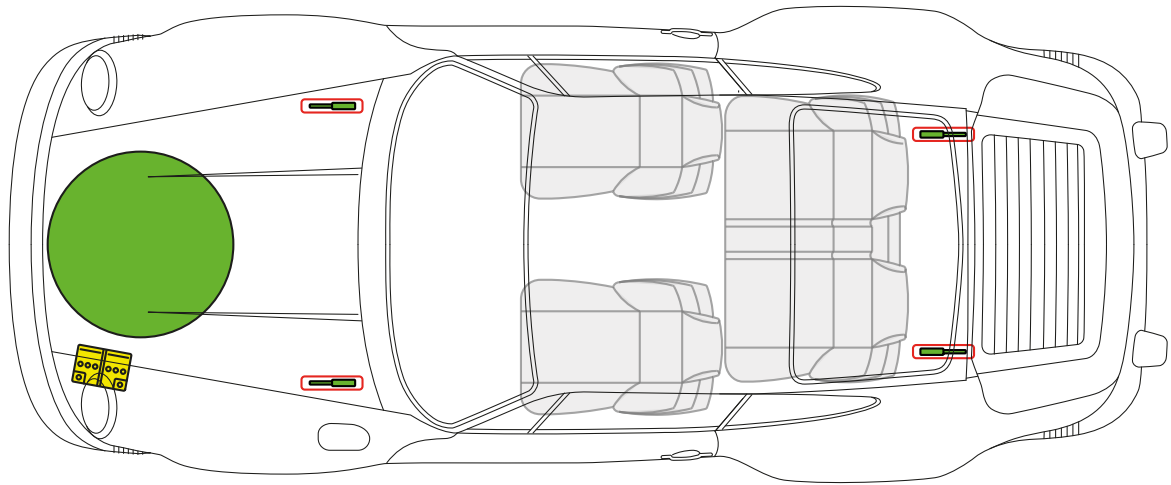

Réservoir de
carburant

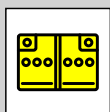

Batterie
12 volts

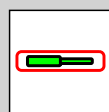

Amortisseur à
gaz



Porsche AG, 911 G-Model Turbo (930), Targa, tous dérivés

PORSCHE AM 1986 à AM 1989

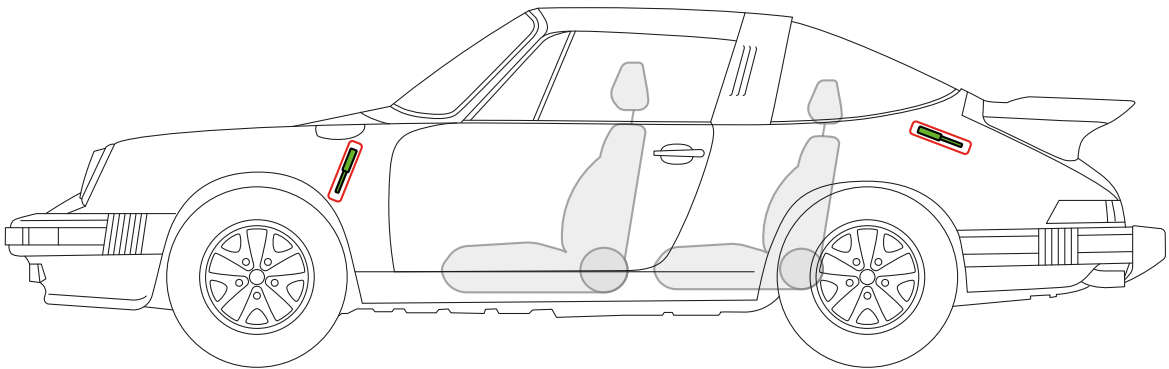
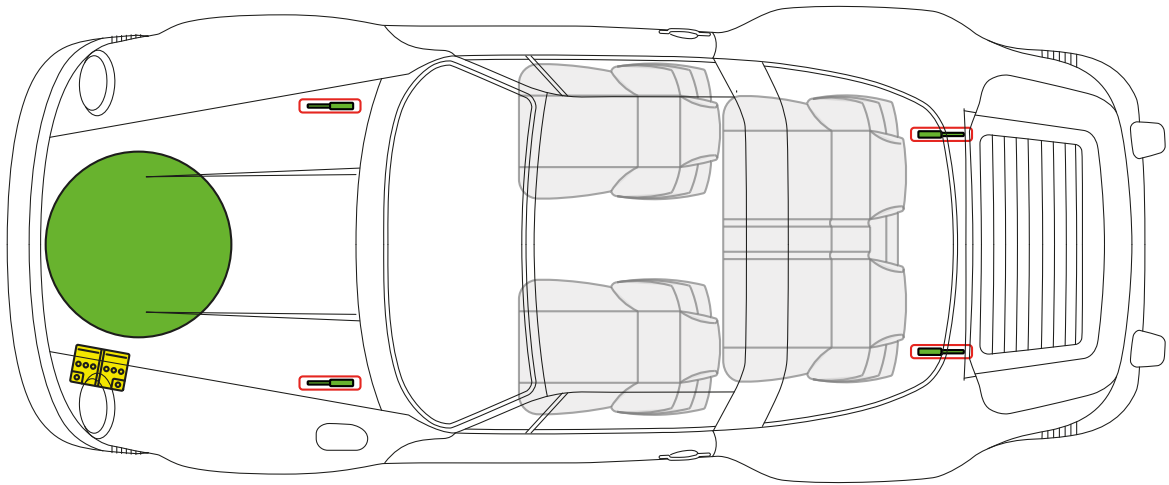
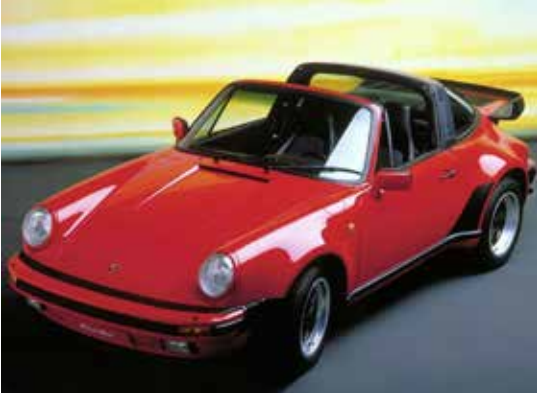

Réservoir de carburant

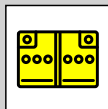

Batterie 12 volts

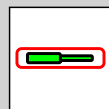

Amortisseur à gaz



Porsche AG, 911 G-Model Turbo (930), Cabriolet, tous dérivés

PORSCHE AM 1986 à AM 1989

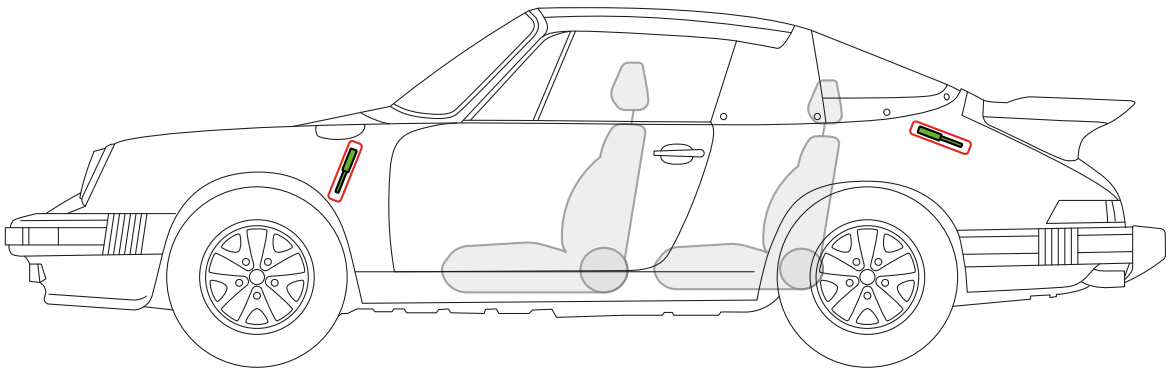
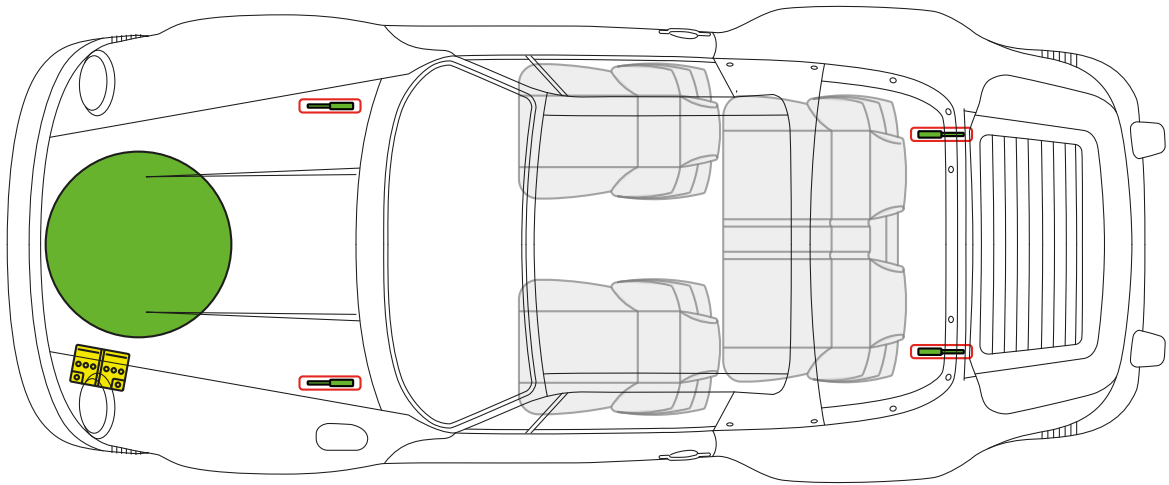

Réservoir de
carburant

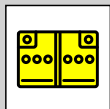

Batterie
12 volts

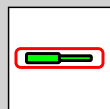

Amortisseur à
gaz



**Porsche AG, 912, 912 E, Coupé,
tous dérivés**

PORSCHE AM 1965 à AM 1969, à partir de l'AM 1976 (912 E)

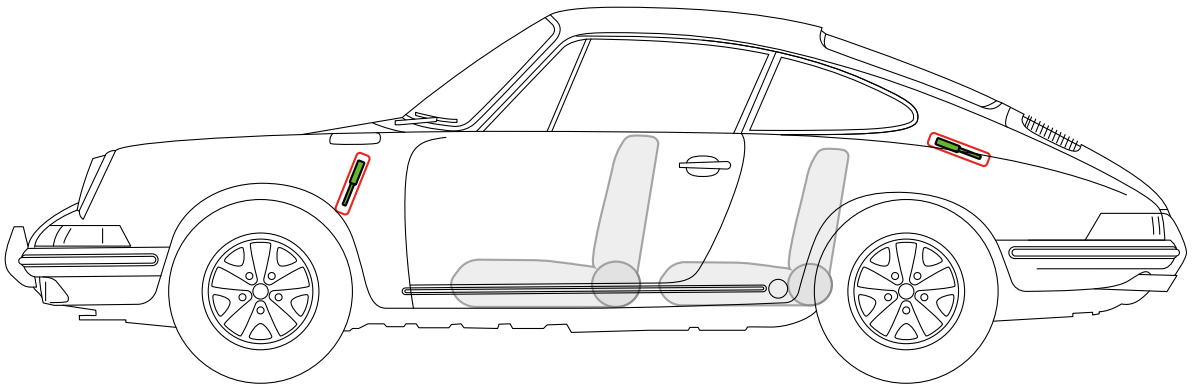
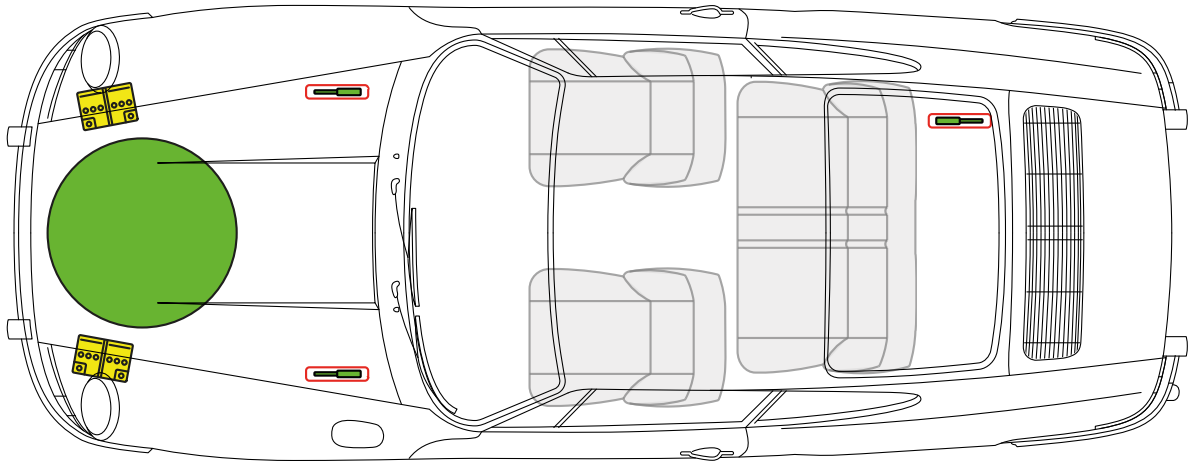

Réservoir de carburant

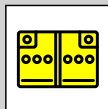

Batterie 12 volts

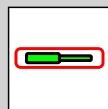

Amortisseur à gaz



**Porsche AG, 912, Targa,
tous dérivés**

PORSCHE AM 1965 à AM 1969,

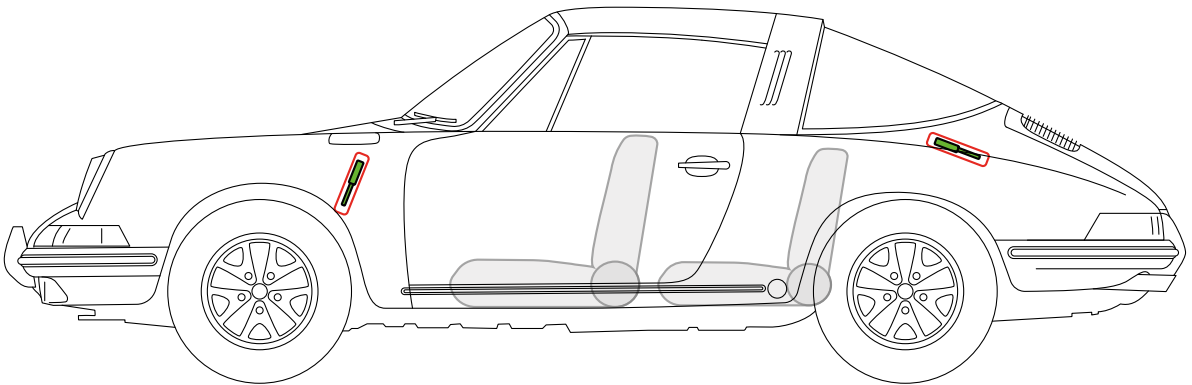
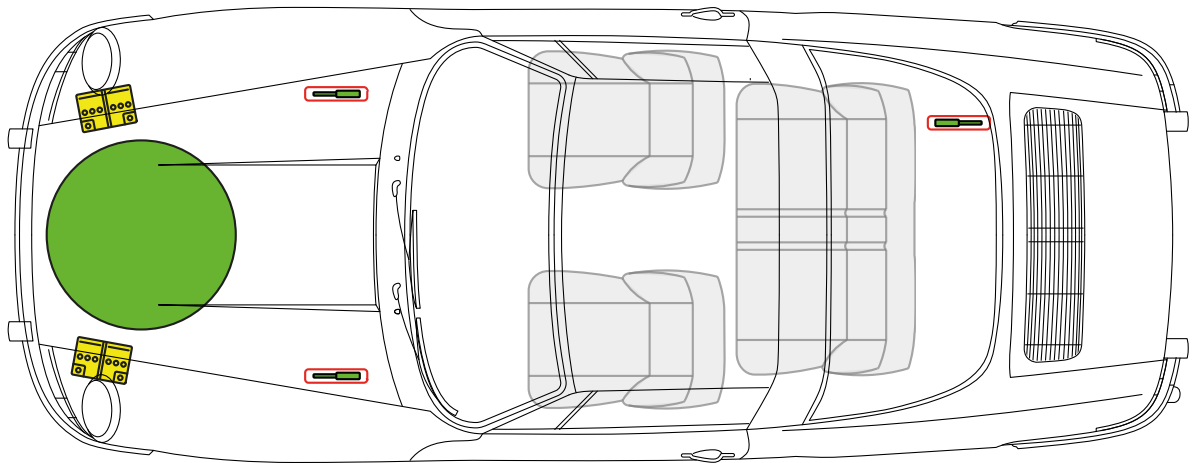

Réservoir de
carburant

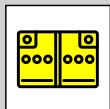

Batterie
12 volts

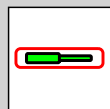

Amortisseur à
gaz



**Porsche AG, 914, Coupé,
tous dérivés**

PORSCHE AM 1976 à AM 1988,

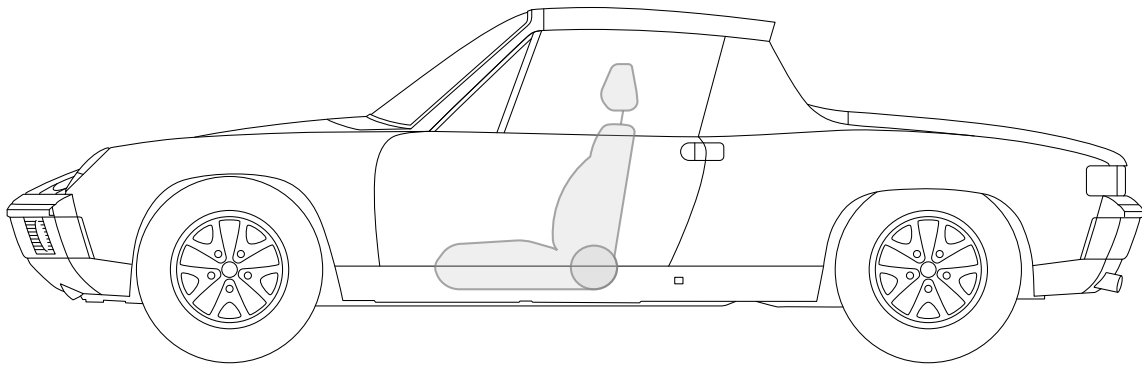
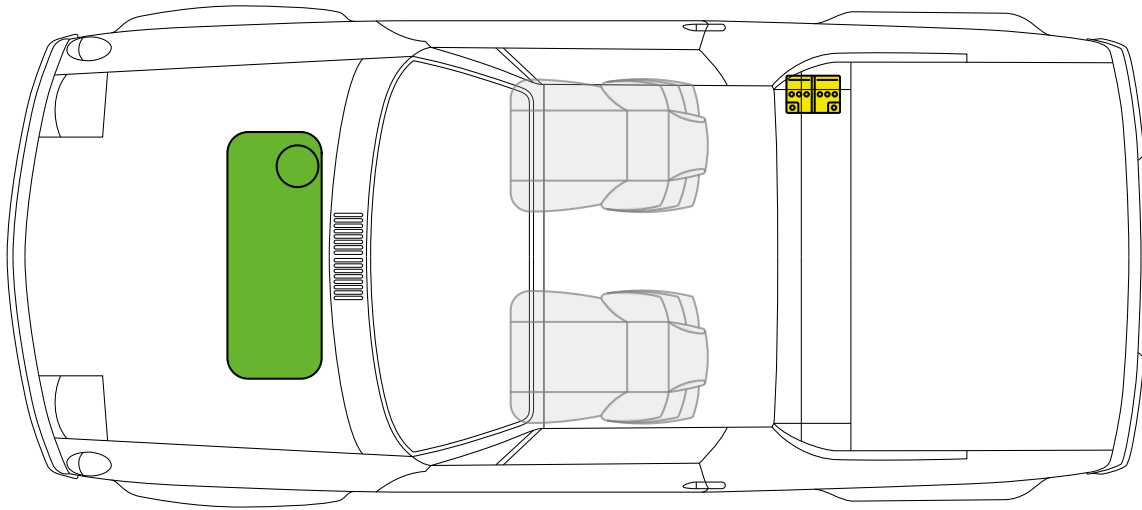

Réservoir de
carburant

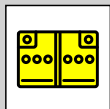

Batterie
12 volts



**Porsche AG, 924, Coupé,
tous dérivés**

PORSCHE AM 1976 à AM 1988,

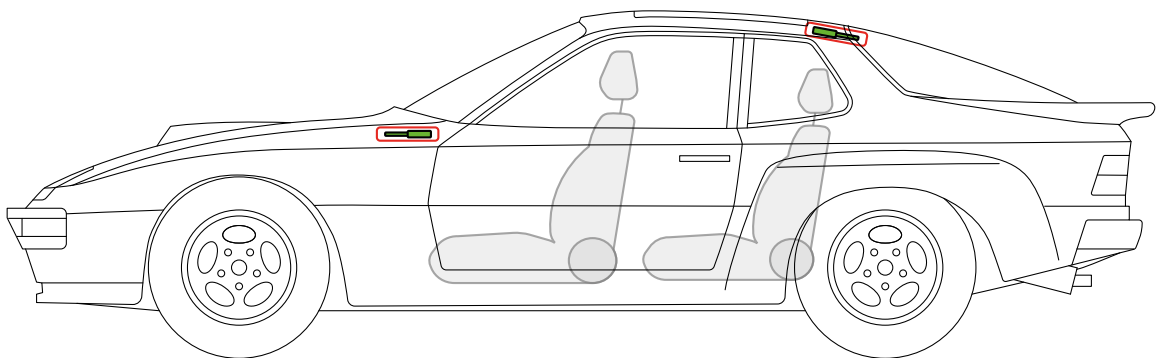
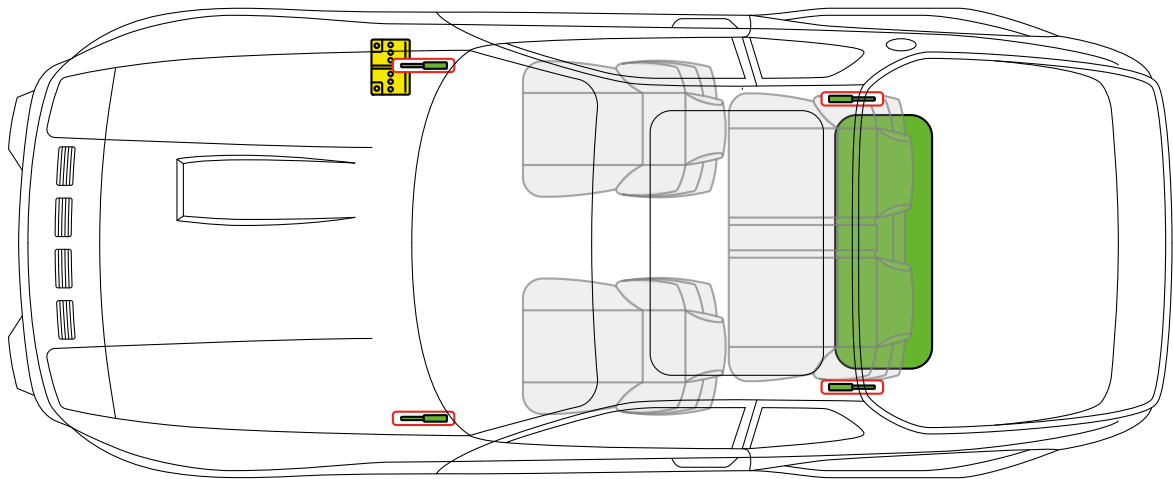

Réservoir de
carburant

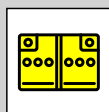

Batterie
12 volts

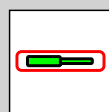

Amortisseur à
gaz



Porsche AG, 928, Coupé, tous dérivés

PORSCHE AM 1977 à AM 1995,

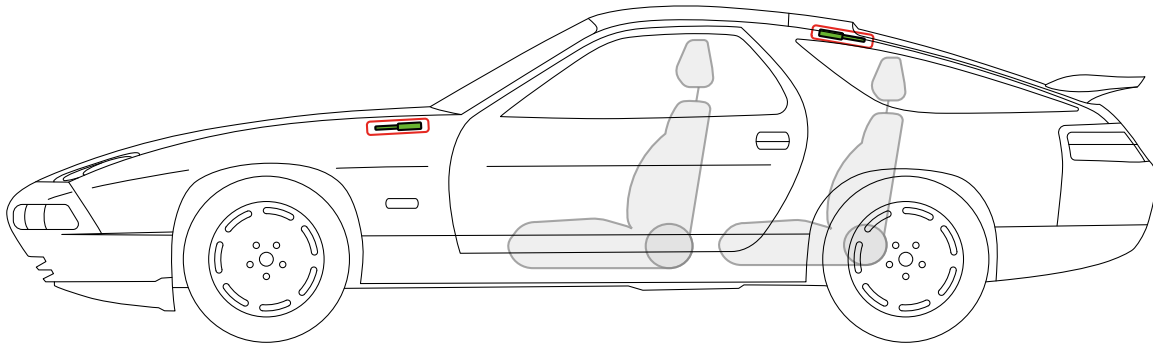
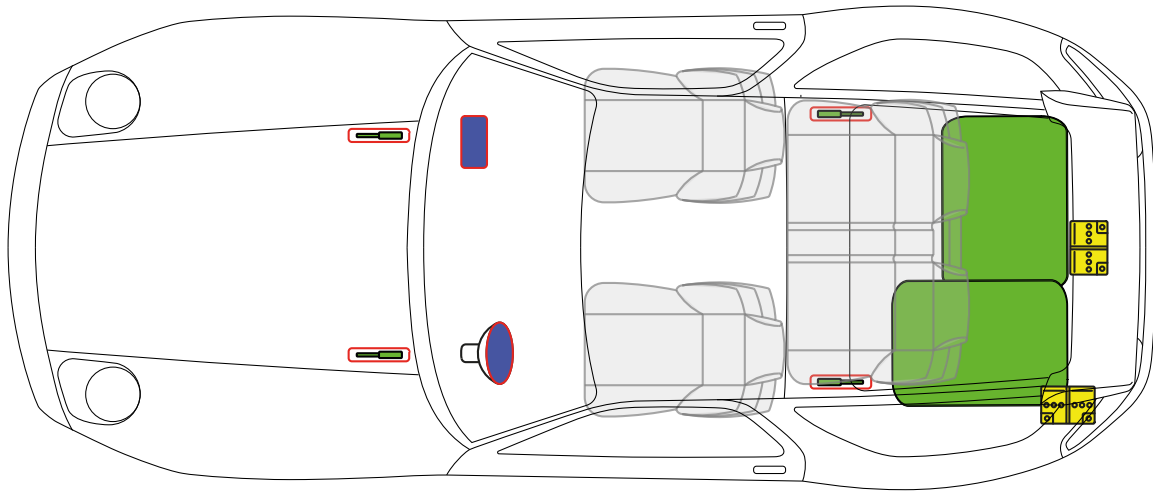

Réservoir de carburant

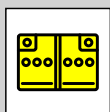

Batterie 12 volts

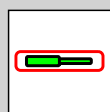

Amortisseur à gaz

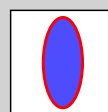

Airbag



Porsche AG, 944, Coupé, Targa, tous dérivés

PORSCHE AM 1982 à AM 1991,

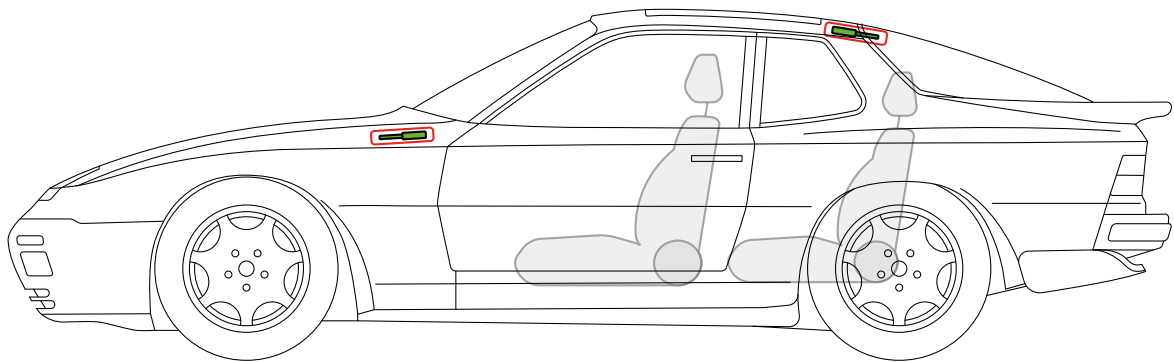
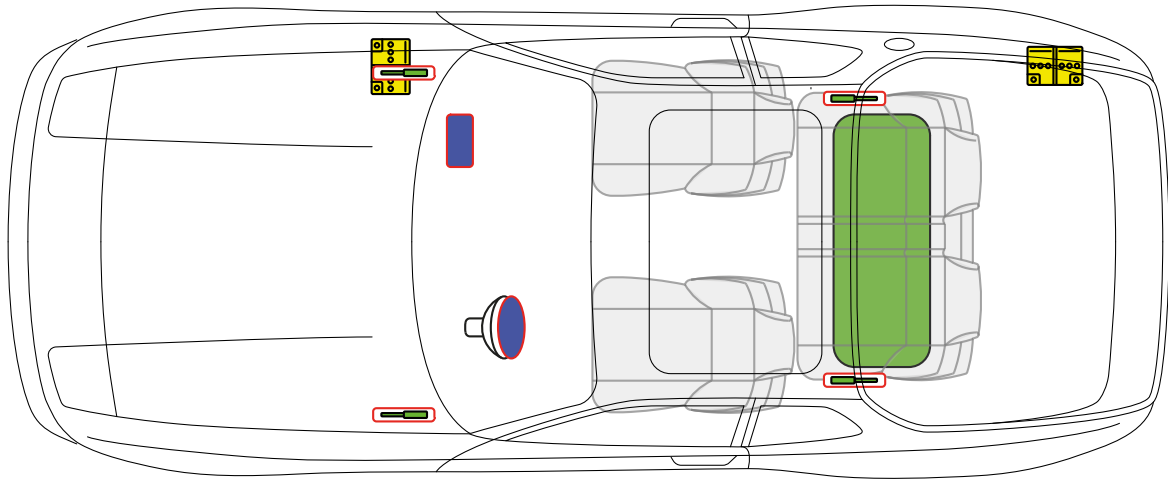
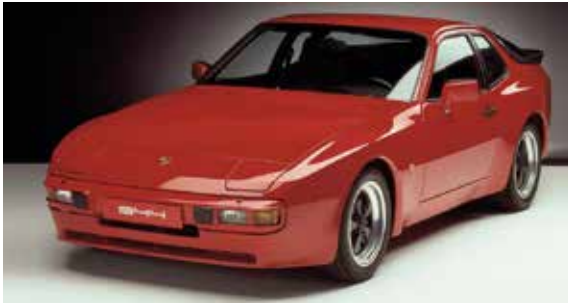

Réservoir de carburant

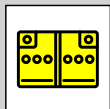

Batterie 12 volts

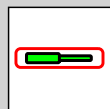

Amortisseur à gaz

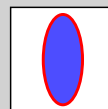

Airbag



**Porsche AG, 944, Cabriolet,
tous dérivés**

PORSCHE AM 1989 à AM 1991,

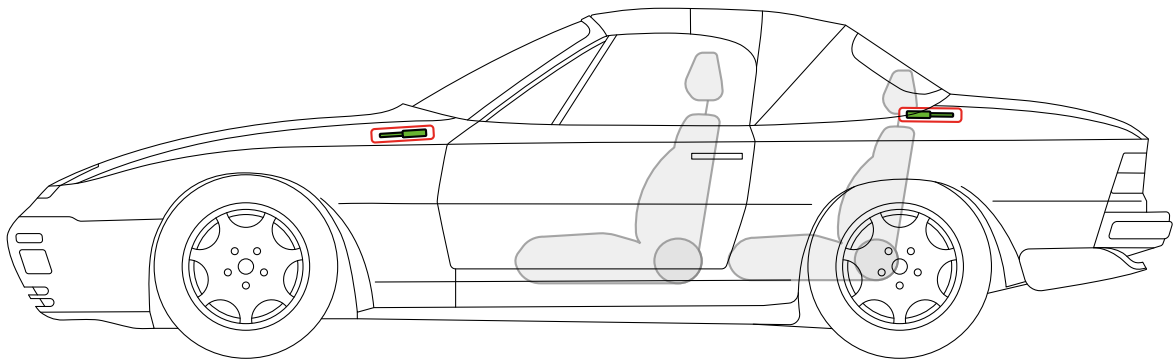
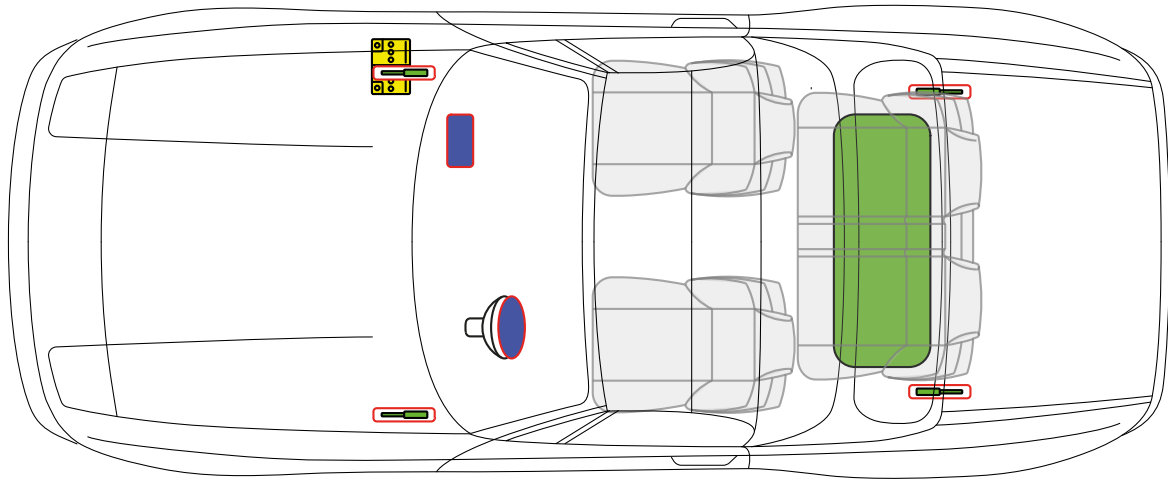

Réservoir de
carburant

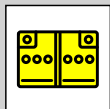

Batterie
12 volts

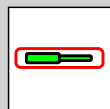

Amortisseur à
gaz

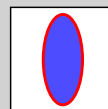

Airbag



**Porsche AG, 959, Coupé,
tous dérivés**

PORSCHE AM 1986 à AM 1988,

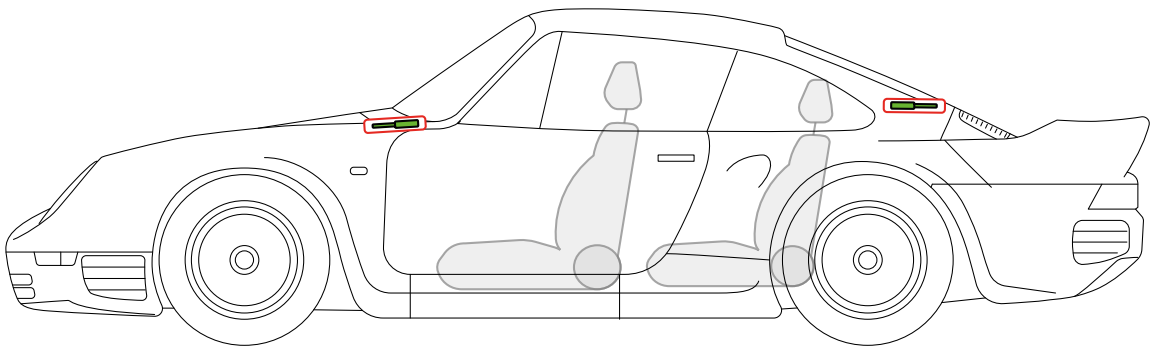
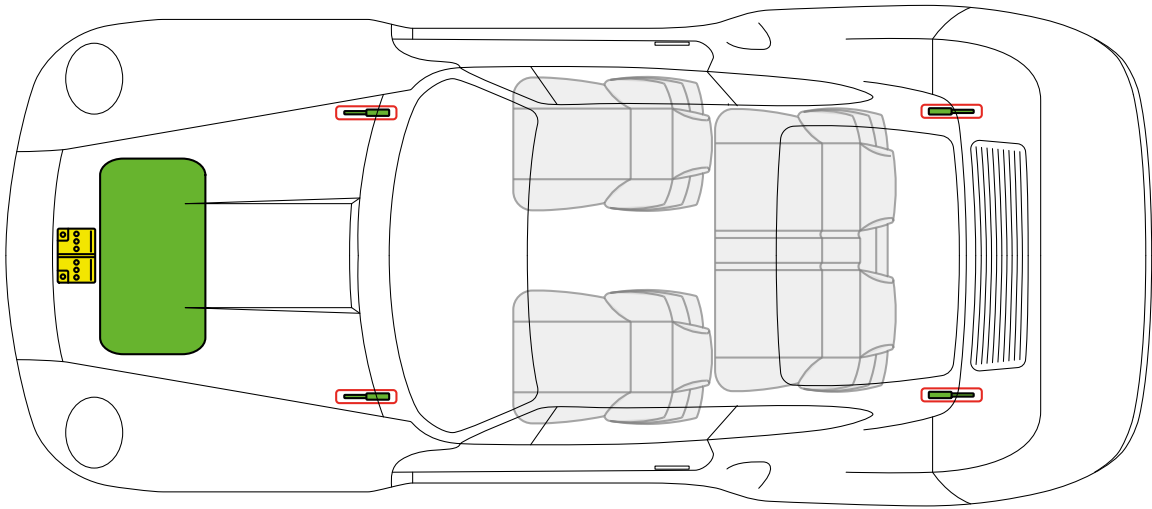

Réservoir de
carburant

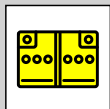

Batterie
12 volts

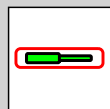

Amortisseur à
gaz



**Porsche AG, 964, Coupé,
tous dérivés**

PORSCHE AM 1989 à AM 1994,

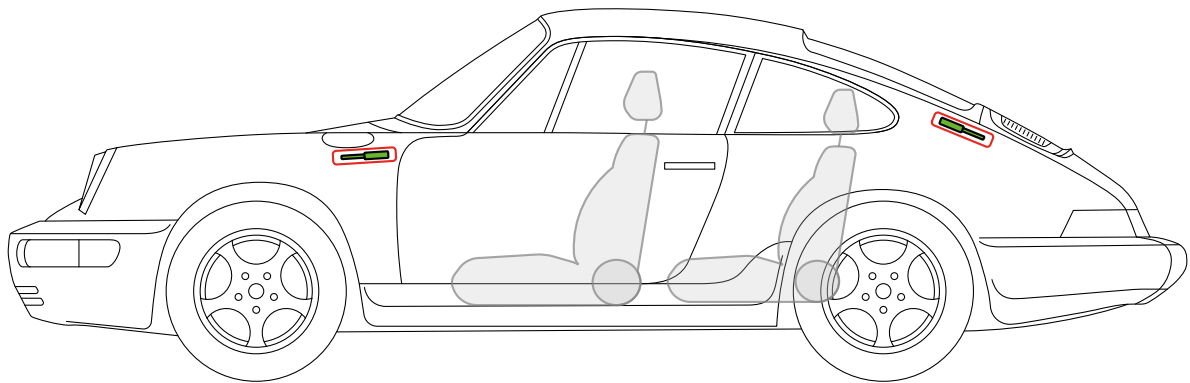
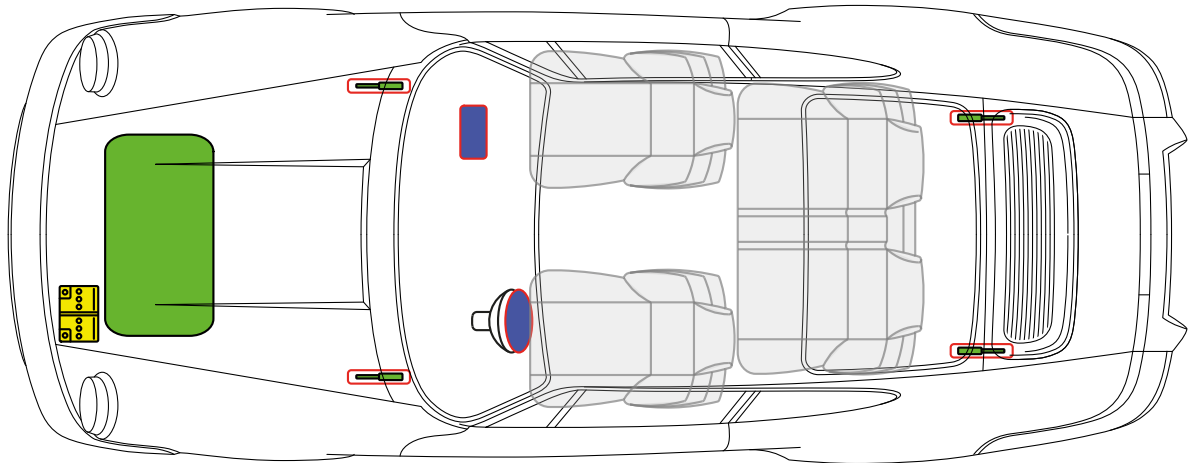
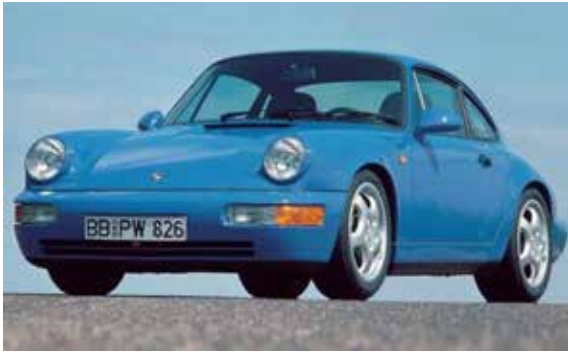

Réservoir de carburant

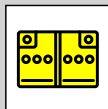

Batterie 12 volts

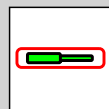

Amortisseur à gaz

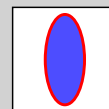

Airbag



**Porsche AG, 964, Targa,
tous dérivés**

PORSCHE AM 1990 à AM 1994,

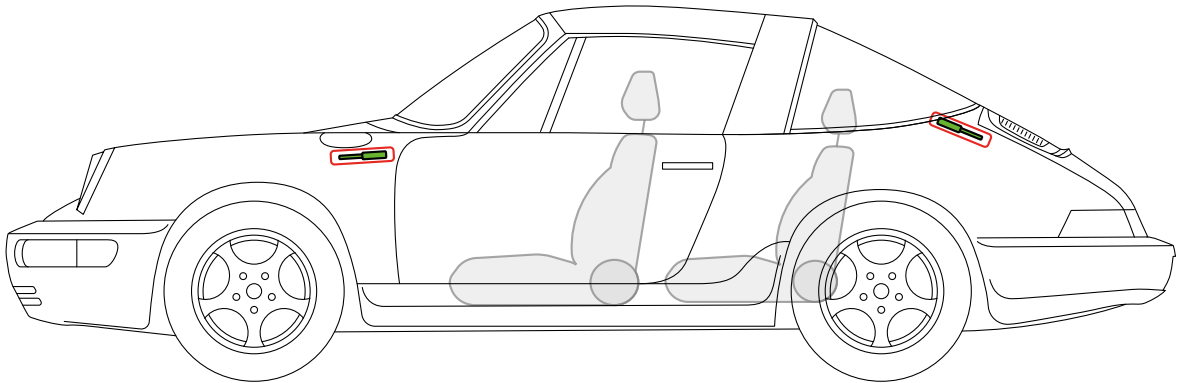
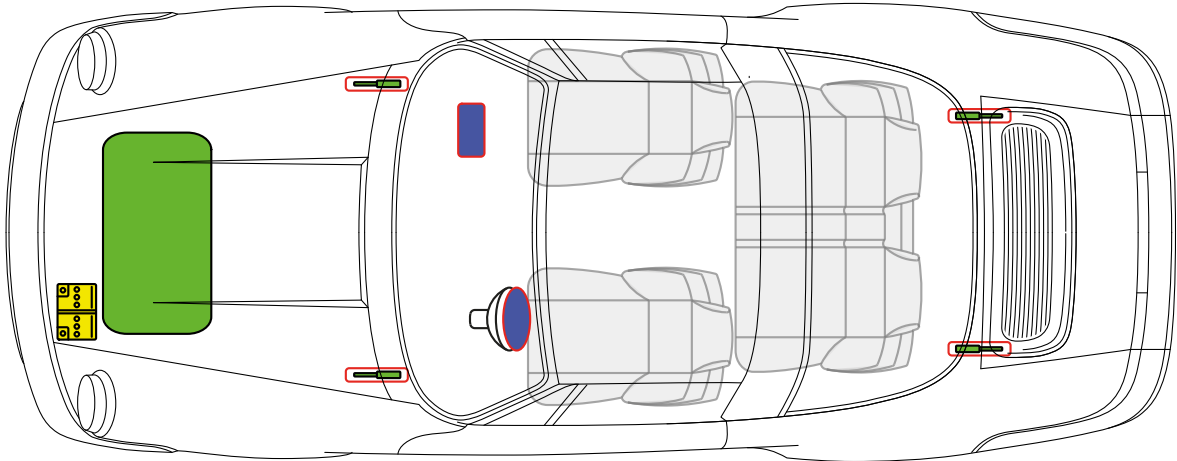

Réservoir de carburant

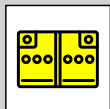

Batterie 12 volts

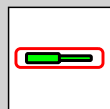

Amortisseur à gaz

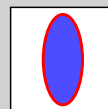

Airbag



Porsche AG, 964, Cabriolet, Speedster, tous dérivés

PORSCHE AM 1990 à AM 1994,

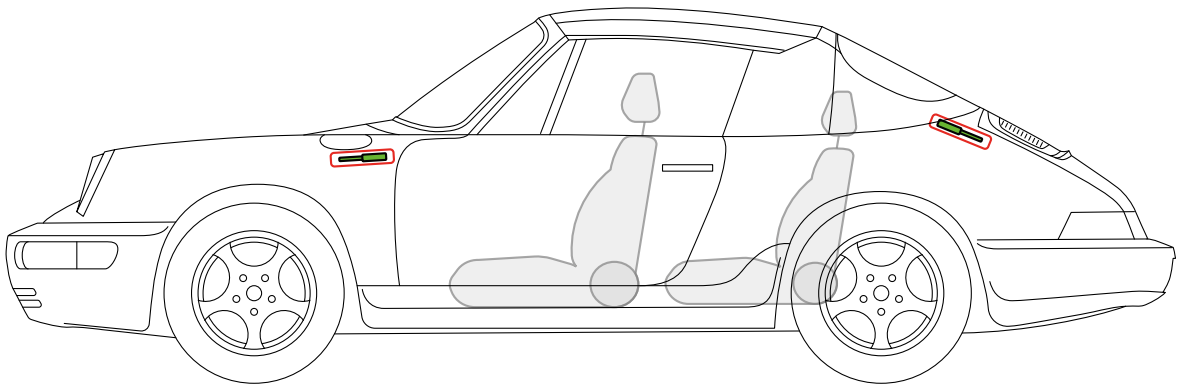
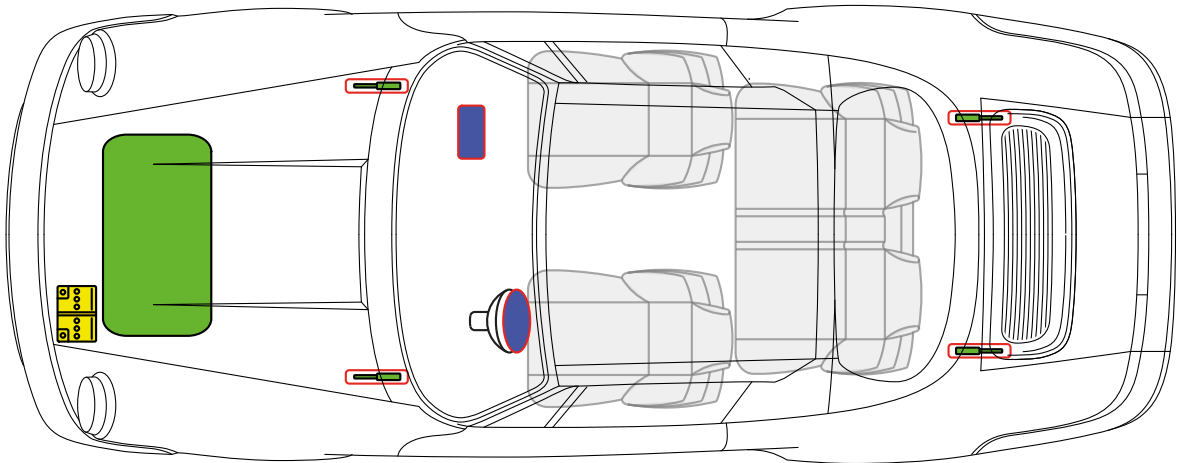

Réservoir de carburant

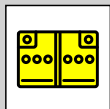

Batterie 12 volts

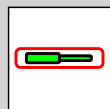

Amortisseur à gaz

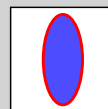

Airbag



**Porsche AG, 964, Turbo, Coupé,
tous dérivés**

PORSCHE AM 1990 à AM 1994,

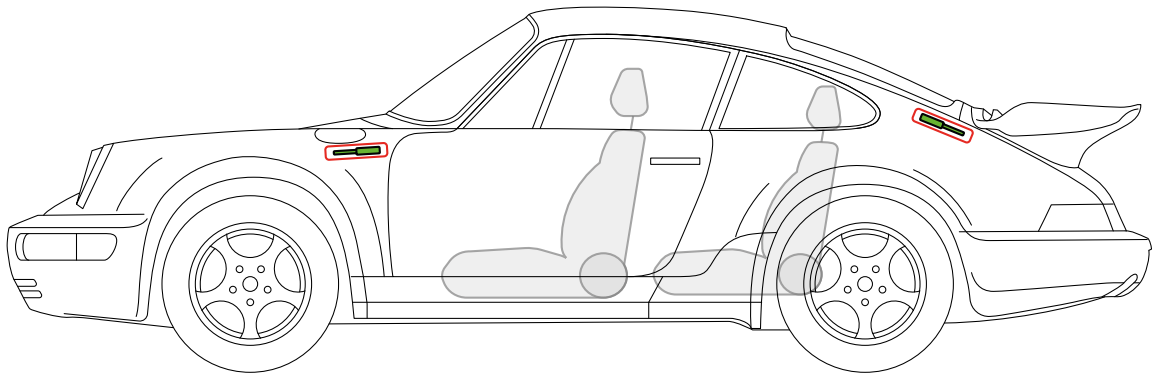
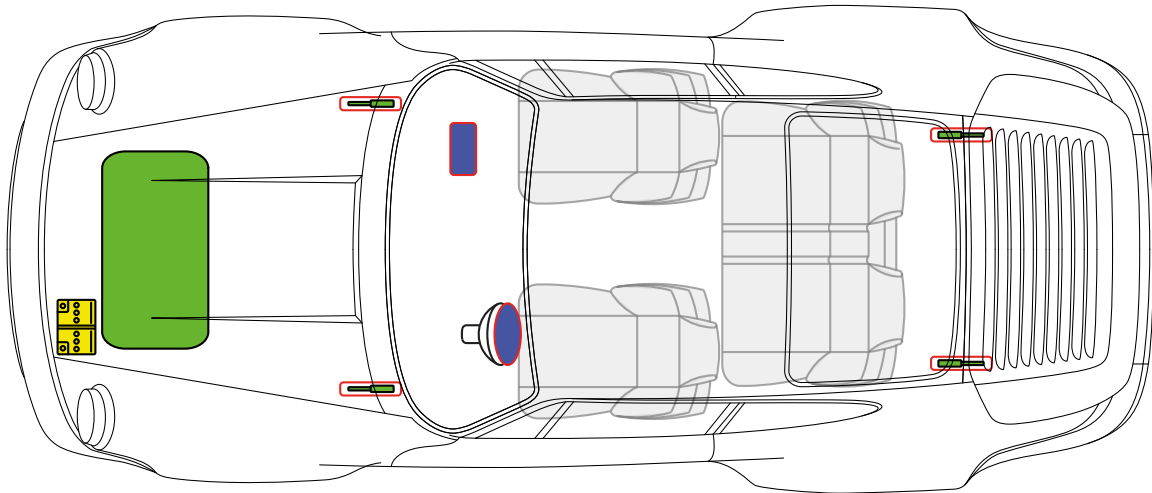
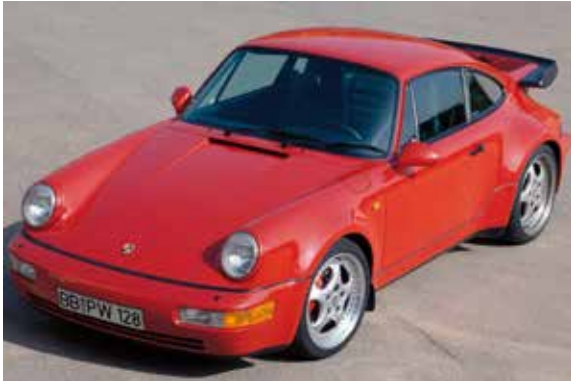

Réservoir de carburant

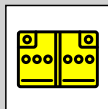

Batterie 12 volts

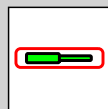

Amortisseur à gaz

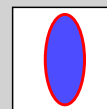

Airbag



**Porsche AG, 968, Coupé,
tous dérivés**

PORSCHE AM 1991 à AM 1995,

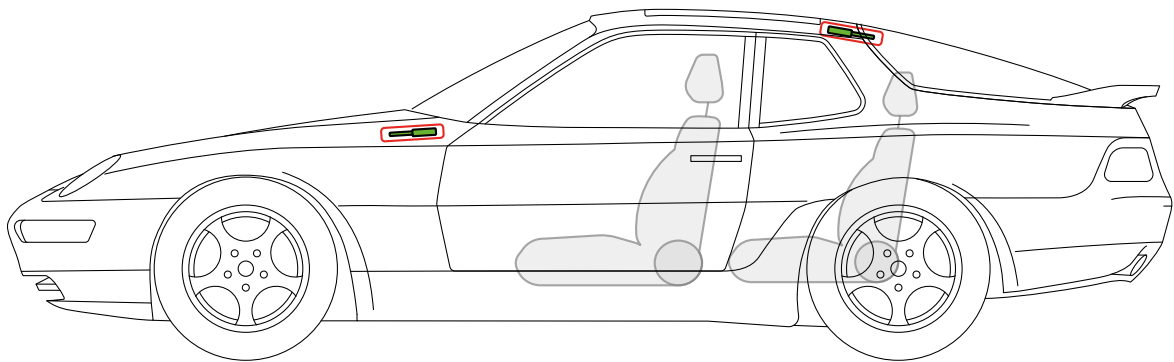
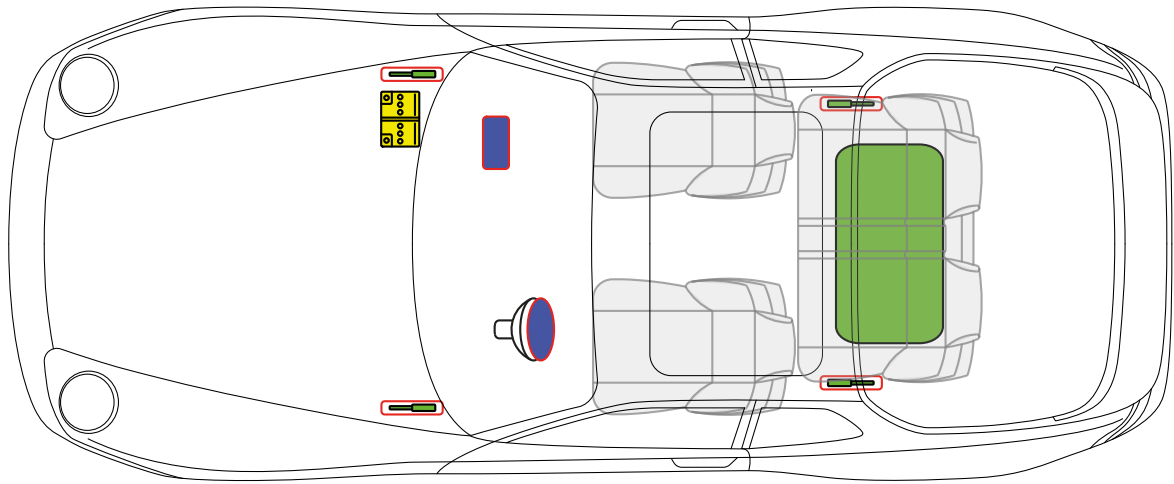

Réservoir de carburant

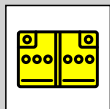

Batterie 12 volts

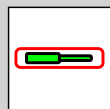

Amortisseur à gaz

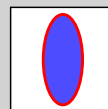

Airbag



**Porsche AG, 968, Cabriolet,
tous dérivés**

PORSCHE AM 1991 à AM 1995,

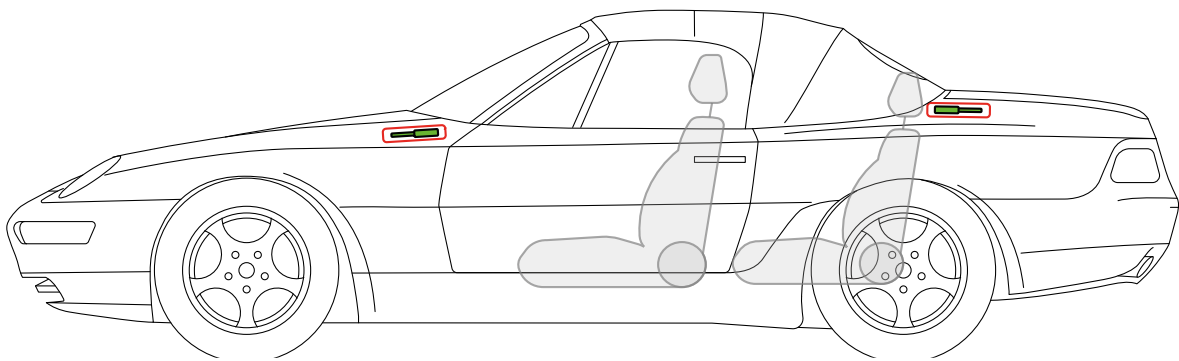
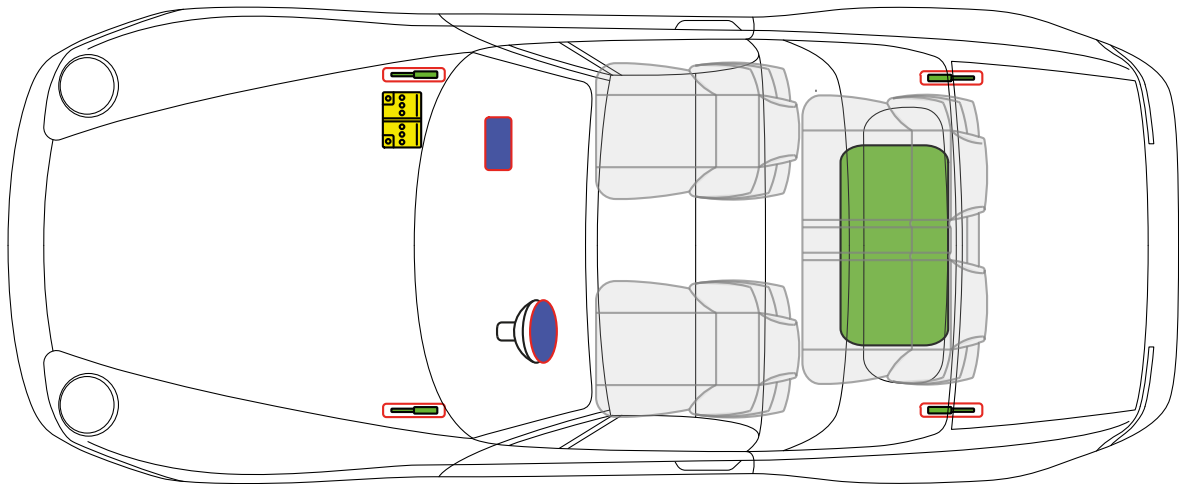

Réservoir de carburant

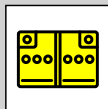

Batterie 12 volts

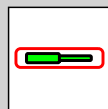

Amortisseur à gaz

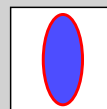

Airbag



Porsche AG, 993, Coupé, tous dérivés

PORSCHE AM 1994 à AM 1998,

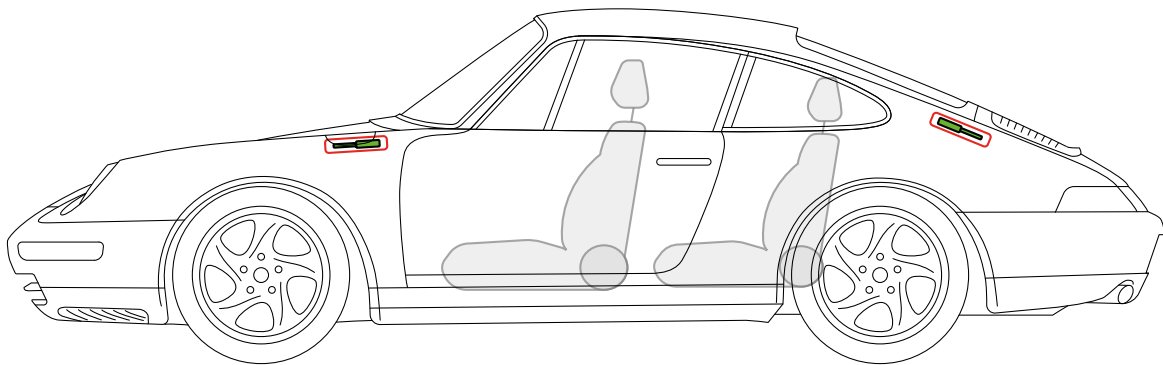
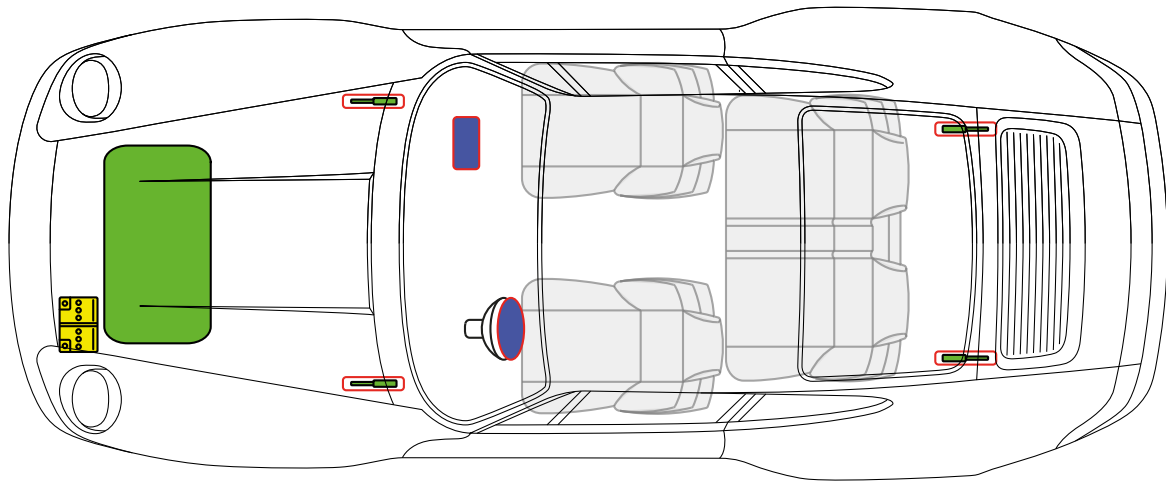

Réservoir de
carburant

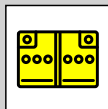

Batterie
12 volts

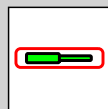

Amortisseur à
gaz

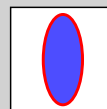

Airbag



**Porsche AG, 993, Targa,
tous dérivés**

PORSCHE AM 1994 à AM 1998,

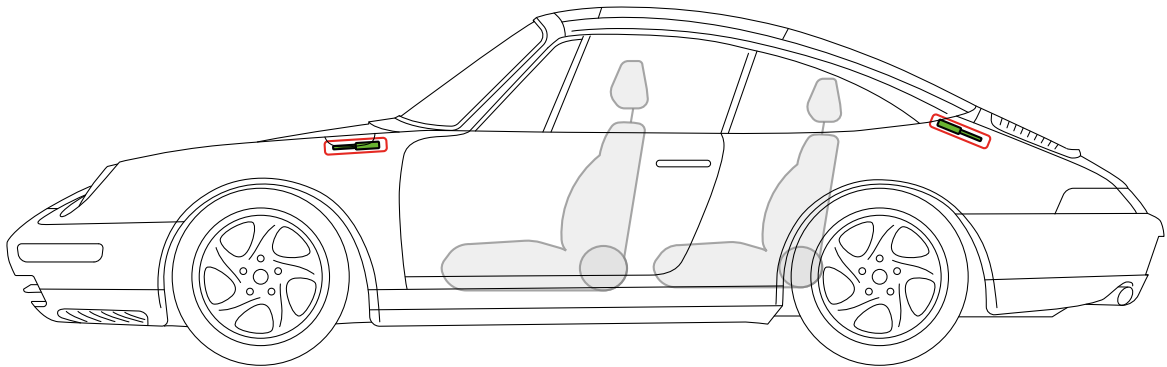
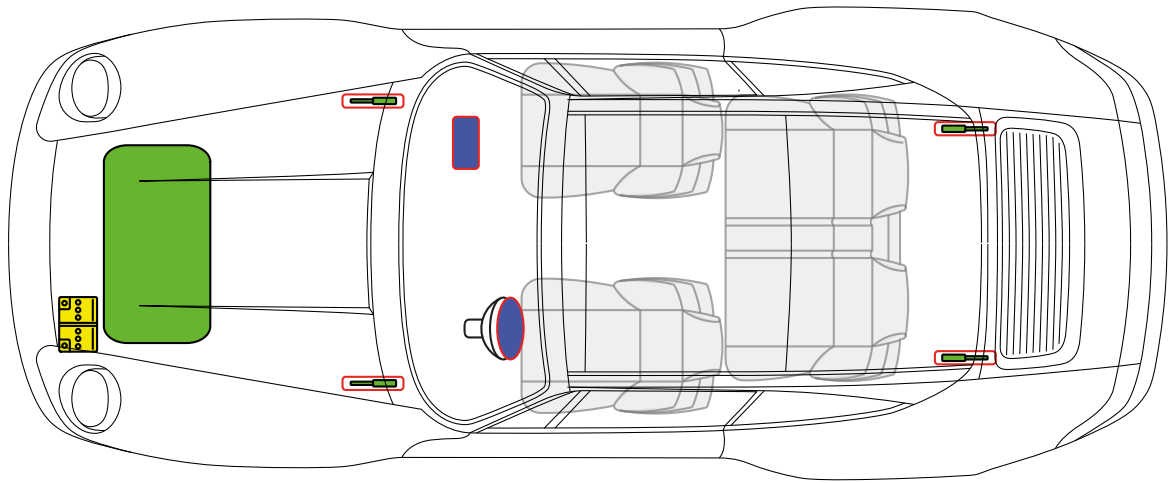

Réservoir de
carburant

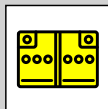

Batterie
12 volts

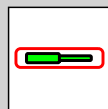

Amortisseur à
gaz

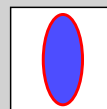

Airbag



**Porsche AG, 993, Cabriolet,
tous dérivés**

PORSCHE AM 1994 à AM 1998,

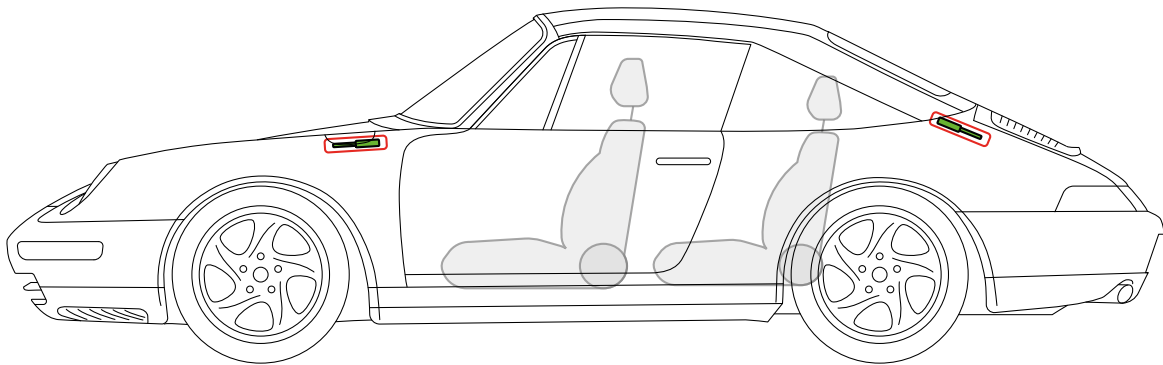
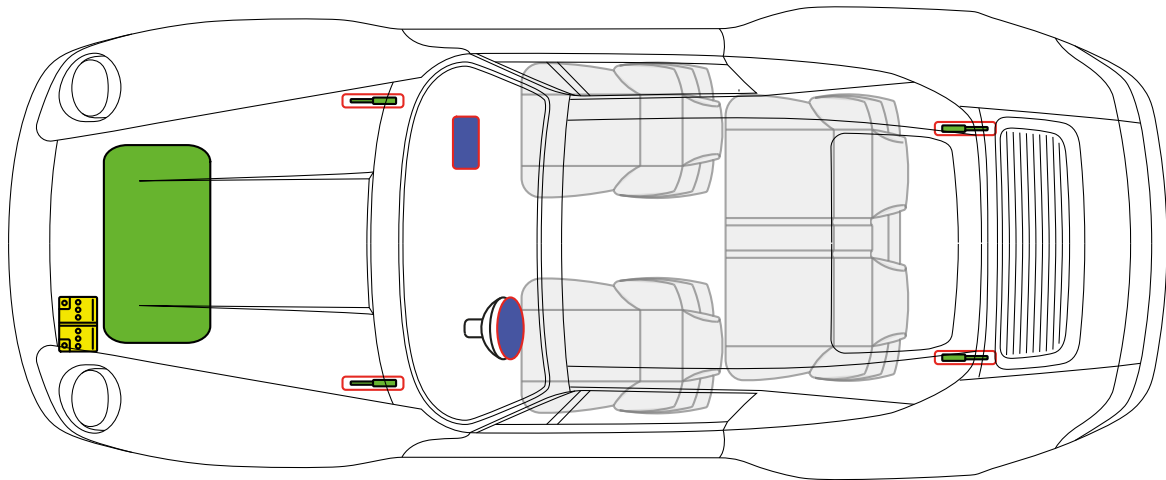

Réservoir de carburant

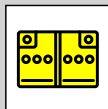

Batterie 12 volts

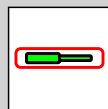

Amortisseur à gaz

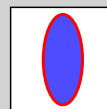

Airbag



Porsche AG, 986, Boxster, Cabriolet, tous dérivés

PORSCHE AM 1997 à AM 2004,

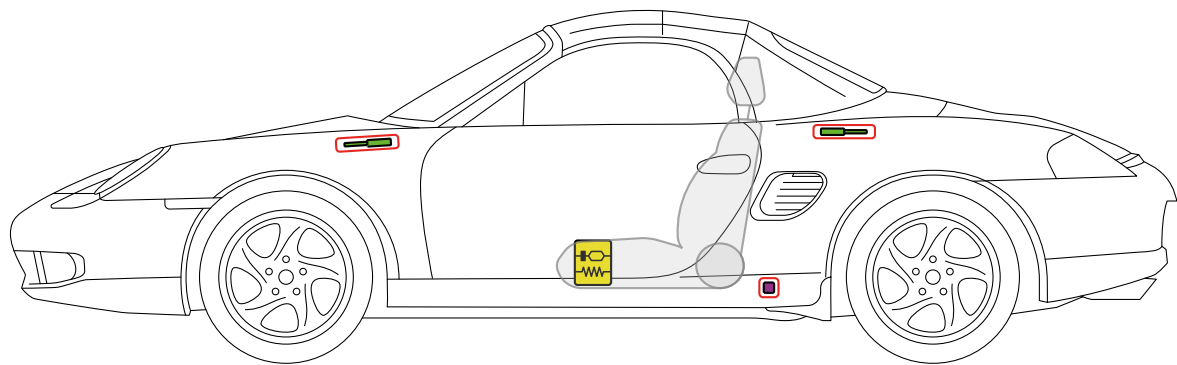
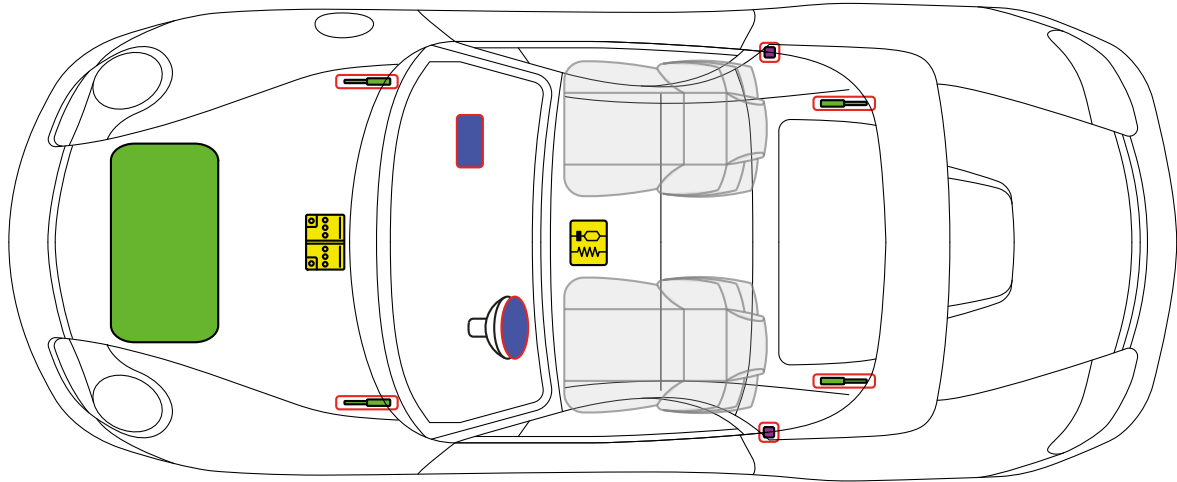

Réservoir de
carburant

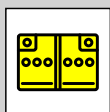

Batterie
12 volts

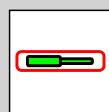

Amortisseur à
gaz

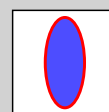

Airbag



Prétensi-
onneur de
ceinture

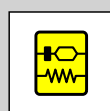

SRS-
Calculateur



**Porsche AG, 996, Coupé,
tous dérivés**

PORSCHE AM 1998 à AM 2005,

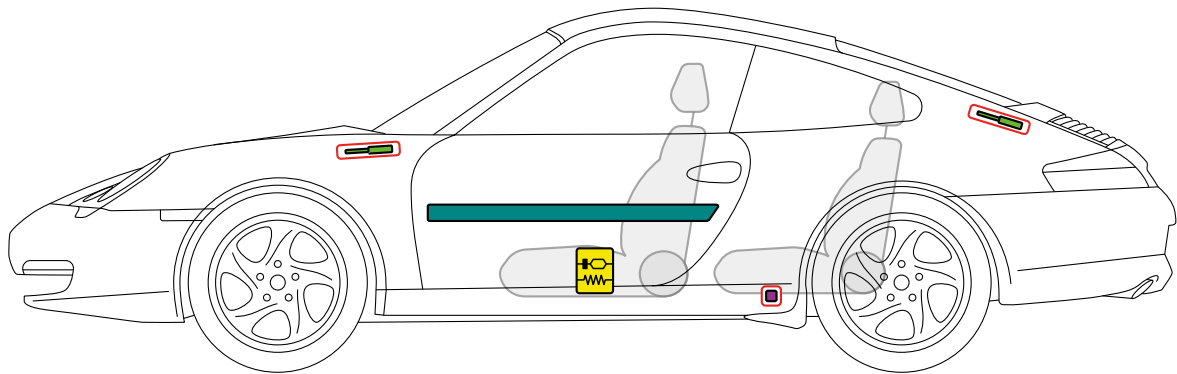
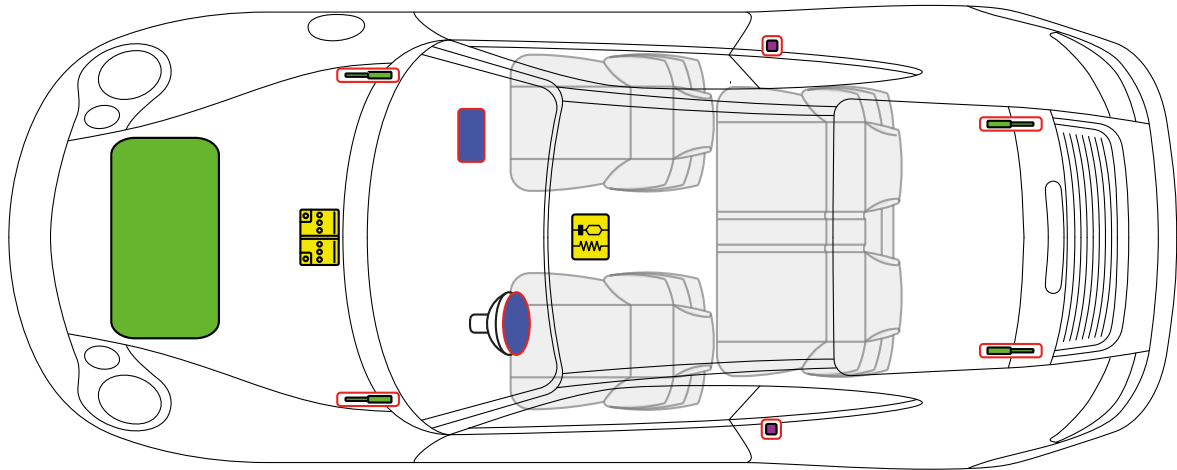
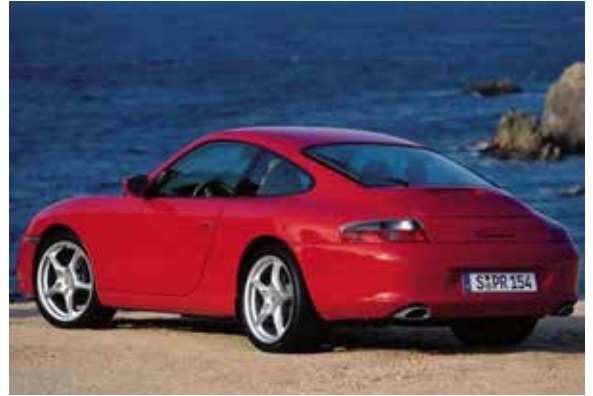

Réservoir de carburant

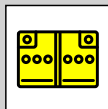

Batterie 12 volts

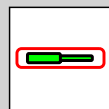

Amortisseur à gaz

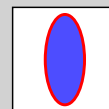

Airbag



Prétensionneur de ceinture

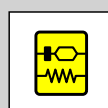

SRS-Calculateur

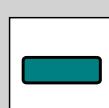

Renforts de carrosserie



**Porsche AG, 996, Targa,
tous dérivés**

PORSCHE AM 1998 à AM 2005,

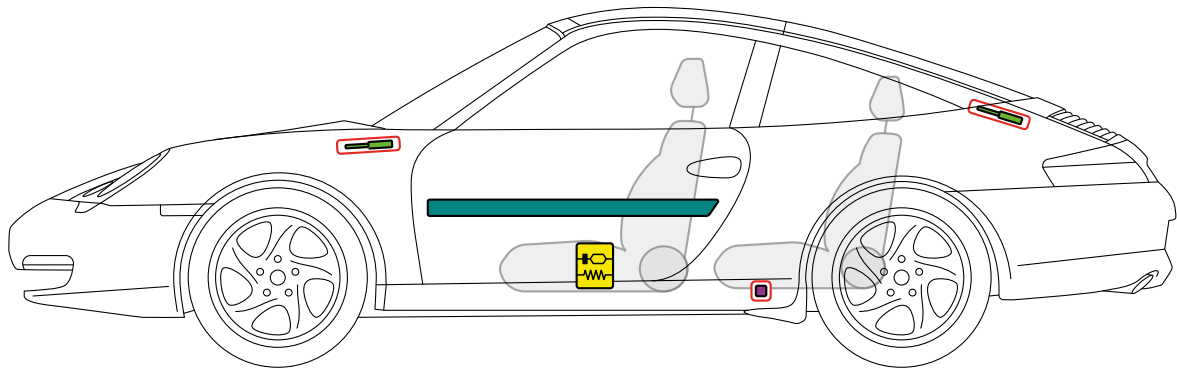
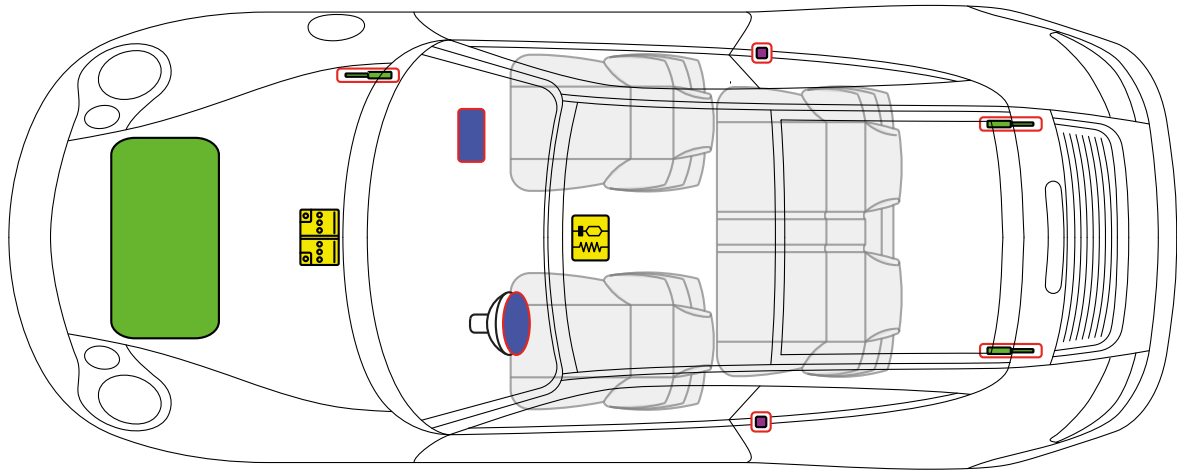

Réservoir de carburant

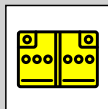

Batterie 12 volts

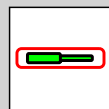

Amortisseur à gaz

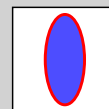

Airbag



Prétensionneur de ceinture

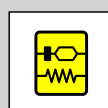

SRS-Calculateur

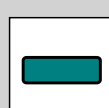

Renforts de carrosserie



Porsche AG, 996, Cabriolet, tous dérivés

PORSCHE AM 1998 à AM 2005,

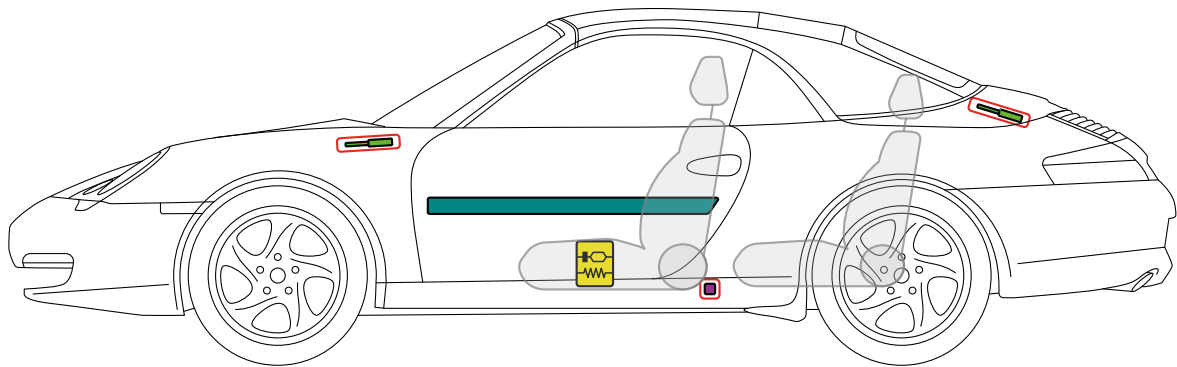
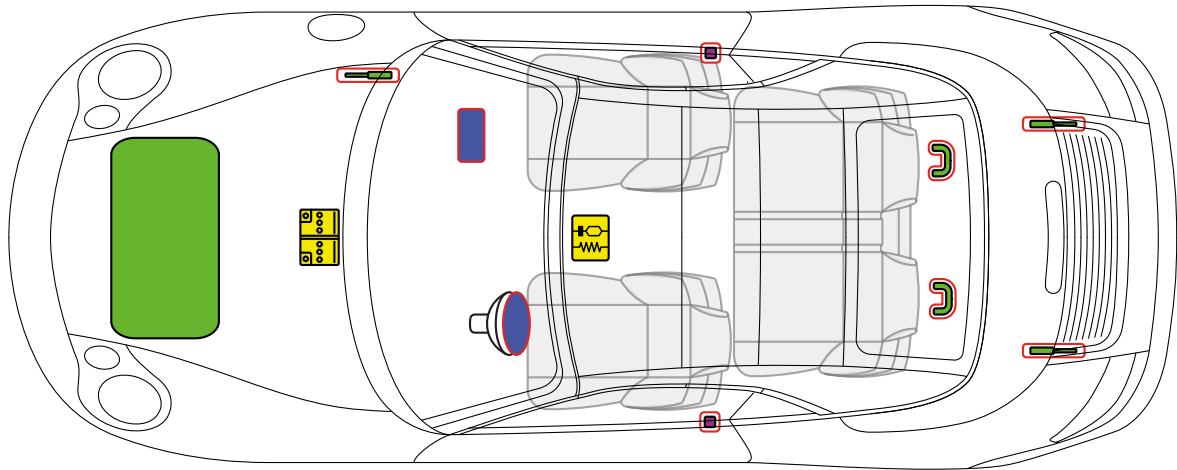

Réservoir de carburant

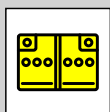

Batterie 12 volts

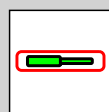

Amortisseur à gaz

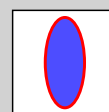

Airbag



Prétensionneur de ceinture

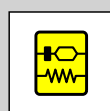

SRS-Calculateur

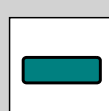

Renforts de carrosserie



Arceaux de sécurité



Porsche AG, 980, Carrera GT, Cabriolet, tous dérivés

PORSCHE AM 2003 à AM 2006,

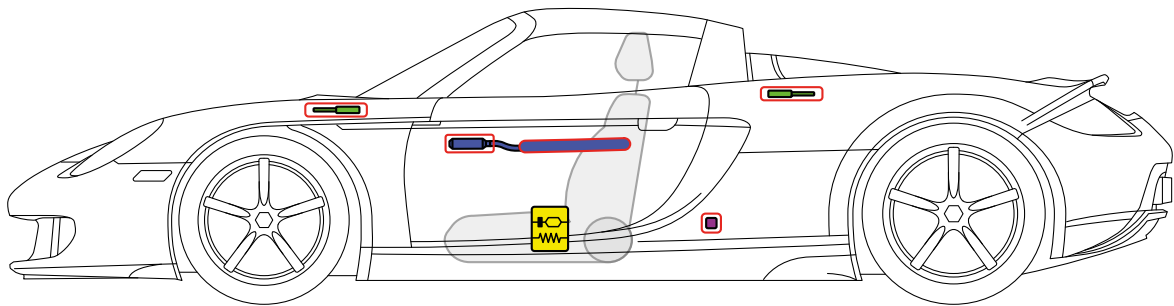
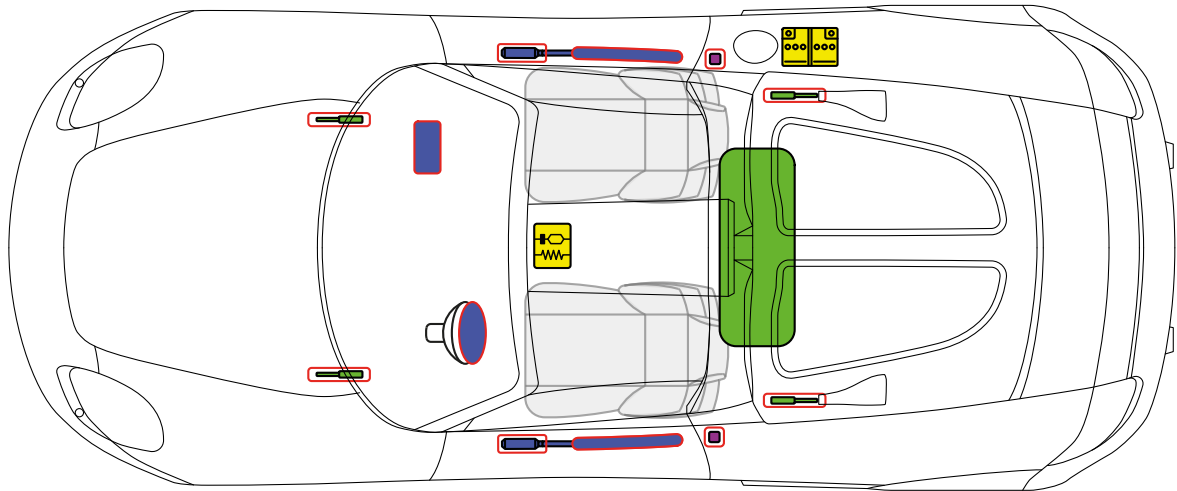

Réservoir de carburant

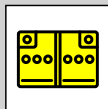

Batterie 12 volts

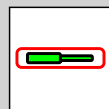

Amortisseur à gaz

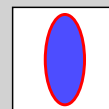

Airbag



Prétensionneur de ceinture

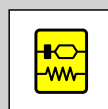

SRS-Calculateur

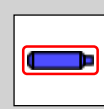

Générateur de gaz